

Ford Sales Company of Australia Limited



Ford Cars

All Model catalogue January 1978



This comprehensive catalogue is designed to introduce you to the wide range of Ford cars available in Australia. It contains

- illustrations
- brief descriptions
- lists of selected standard equipment
- various technical specifications
- a selection of the extra cost options which are available for each of the models referred to.

One thing will become obvious to you as you study

these pages—there is a Ford model to satisfy almost every type of car buyer.

If you require a small car, there is the range of European Formula Ford Escorts; in the medium-car field, the Cortina range of sedans and wagons; for larger car buyers, the popular range of Ford Falcons and Fairmonts. If your taste runs to larger, more prestigious motoring, you can select from the Fairlane 500, Fairlane Marquis or Ford LTD models.

Ford has a way of motoring for just about everyone—so if you make "Going Ford the Going Thing" . . . you should find a Ford car to suit your needs.

As changes may be made from time to time to the range of products, and their specifications, standard equipment levels and options available, always consult your Ford Dealer for the latest information before placing your order.

Make your move with Ford Escort

The European Formula Small Car.



Illustrated above: Ford Escort 2-litre 2-door sedan with optional GS Rally Pack (available at extra cost).

FORD ESCORT 2 LITRE with GS Rally Pack . . . it moves!

Escort 2-litre GS. Sporty. Bold. Young-spirited. It's a package with the kind of performance and an equipment level that takes 'small car' motoring up into the big league.

To make it all happen simply pick your model . . . 2-litre GL sedan in either 2 or 4 door form, then order the GS Pack*. You get the added go of a 94 hp (70 kW) overhead cam engine that puts out 109 lbs. ft. (148 Nm) of torque. And you get lots of sports-type equipment like rear spoiler (not on the Van) and sports steel road wheels. Steel-belt radials. Bold, body-side tape stripes. Sports steering wheel. Comprehensive instrumentation including tachometer. Long range driving lights. And more.

Standard transmission in an all-synchro manual floor-shift, or you can order the optional-extra-cost T-bar automatic. Both are housed in a sporty console.

*The GS Rally Pack is optional at extra cost. Refer to Page 10 for details.

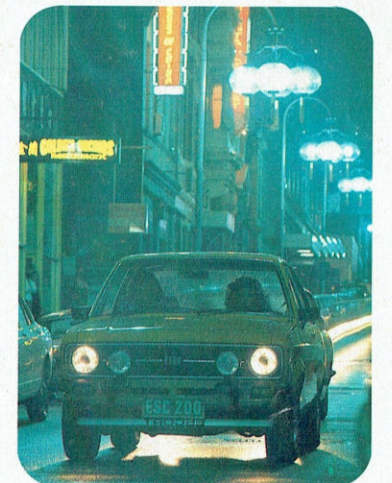

Illustrated above and far right: Ford Escort 2-litre Sedan with optional GS Rally Pack, 'Volante' road wheels and front spoiler (available at extra cost)

Illustrated below: Ford Escort 1.6 litre GL Van and Ford Escort 1.6 litre L Sedan.



ESCORT L & GL VANS

FORD ESCORT L VAN STANDARD EQUIPMENT HIGHLIGHTS:

- ★ 1.6 litre crossflow head engine
- ★ 4-speed floor shift manual transmission
- ★ Power front disc brakes
- ★ Cross ply tyres
- ★ Front bucket seats
- ★ Outboard inertia reel front seat belts
- ★ Prismatic day/night interior rear-view mirror
- ★ Ventilation system with individual directional ball vents and under-dash vents
- ★ 2 speed heater/demister with illuminated slide controls
- ★ 2 speed wipers and 2 jet washers
- ★ Steering column control stalks for
 - Turn signal/lane change, high/low beam, Headlight flasher, horn and
 - Flick-wipe[®] wipers/washer
- ★ Imported perforated grained vinyl seat upholstery
- ★ Styled right hand exterior rear-view mirror
- ★ Left-hand side exterior rear-view mirror
- ★ Interior courtesy light operated by front doors
- ★ Front passenger side parcel shelf
- ★ Driver's side trinket tray

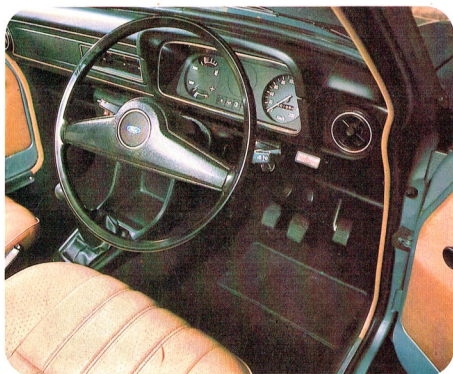

Illustrated above: Ford Escort GL Van interior

- ★ Hazard flashers
 - ★ Rubber floor mat in passenger compartment
- ### FORD ESCORT GL VAN STANDARD EQUIPMENT HIGHLIGHTS
- As for Escort but with these additional features which are not standard on Escort L:
- ★ Quartz halogen headlights
 - ★ AM push-button radio
 - ★ Centre console
 - ★ Cigarette lighter (illuminated)
 - ★ Bumper rub strips
 - ★ Radial-ply tyres
 - ★ Loop-pile carpeting in passenger compartment
 - ★ Rear load area rubber mat

ESCORT 1.6 L SEDAN

If your taste is for a 2-door, here's European-style flair, style and features to make driving a real pleasure.

Escort L is powered by an economical 1.6 litre crossflow engine that's equally at home around town or on the open highway. And this power is matched to a 4-speed floor shift transmission that's great to handle.

And your comfort is taken care of with reclining front bucket seats, carpeting and directional ventilation.

FORD ESCORT L STANDARD EQUIPMENT HIGHLIGHTS:

- ★ 1.6 litre crossflow head engine
- ★ 4-speed floor shift manual transmission
- ★ Power front disc brakes
- ★ Radial ply tyres
- ★ Reclining front bucket seats
- ★ Outboard inertia reel front seat belts
- ★ Prismatic day/night interior rear-view mirror
- ★ Ventilation system with individual directional ball vents and under-dash vents
- ★ 2 speed heater/demister with illuminated slide controls
- ★ 2 speed wipers and 2 jet washers
- ★ Steering column control stalks for
 - Turn signal/lane change, high/low beam, Headlight flasher, horn and
 - Flick-wipe[®] wipers/washer
- ★ Loop pile carpeting
- ★ Imported perforated grained vinyl seat upholstery
- ★ Bodyside protection mouldings
- ★ Styled right hand exterior rear-view mirror
- ★ Interior courtesy light operated by front doors
- ★ Front passenger side parcel shelf
- ★ Driver's side trinket tray
- ★ Tinted rear window
- ★ Hazard flashers



FORD ESCORT 1.6 LITRE GL 2 LITRE GL

Well appointed with European flair

Available in 2-door or 4-door form, there's even more to get excited about in Ford Escort GL. You've a choice of 1.6 litre and 2-litre models. In addition to reclining front bucket seats and carpeting, there's a handy centre console with an AM push-button radio. Flick on the headlights and you'll make another discovery, too—GL has quartz halogen headlights for brighter night driving. Among other additional items are bumper rub strips for added protection.

Whichever model you choose, it comes with a sporty 4-speed floor shift, or you can opt for the 3-speed T-bar automatic (available at extra cost). And you feel in control with GL's responsive rack-and-pinion steering, radial ply tyres and front power disc brakes.

If you appreciate plenty of features... with European-style flair... Ford Escort GL is your car.

FORD ESCORT GL STANDARD EQUIPMENT HIGHLIGHTS

As for Escort L but with these upgraded features.

- ★ Quartz halogen headlights and with these additional features which are not standard on Escort L:
- ★ AM push-button radio
- ★ Electric rear window demister
- ★ Centre console
- ★ Bumper rub strips
- ★ Outboard passenger grab handles
- ★ Wheelcovers
- ★ Cigarette lighter



Illustrated right: GL interior with optional T-bar automatic (available at extra cost).

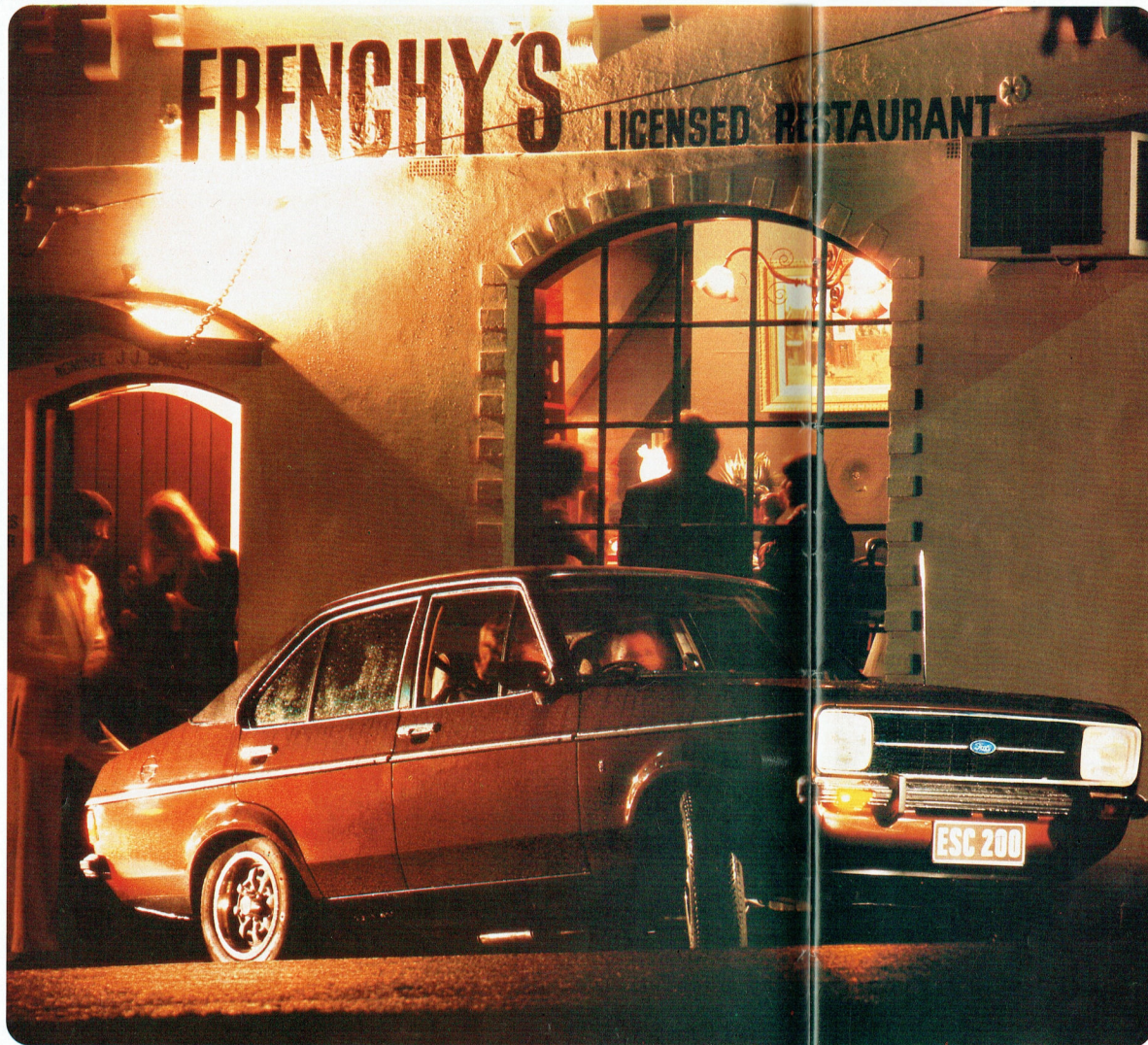

Illustrated above and below: Escort Ghia interior with optional air-conditioning and T-bar automatic (available at extra cost).

FORD ESCORT 2-LITRE GHIA

Just about everything you can think of in a small car has been thought of.

In terms of luxury and standard appointments, Escort Ghia ranks highly against many other light cars costing considerably more.

It's a standard of luxury born and bred in Europe... the home of highly appointed and high performing light cars.

The seating, upholstered in imported cloth; the timber veneer dash; the tinted side and rear windows... the quietness of the interior... and the exhilarating performance from its 2 litre overhead cam engine... Ghia is a car that has to be sat in, switched on and driven to be fully appreciated.

For now, this extensive standard equipment list will at least give you some appreciation of how a light car can be so luxurious.

FORD ESCORT GHIA STANDARD EQUIPMENT HIGHLIGHTS

As for Escort 2-litre GL but with these upgraded features:

- ★ Steel belt radial ply tyres
- ★ Carpeted kick pads on doors
- ★ Imported Verona and Cashmere cloth seat upholstery
- ★ Styled remote control right hand rear view mirror
- ★ Front passenger side glove box
- ★ Two spoke 'soft feel' steering wheel
- ★ Dual tone horn
- ★ Tinted-band, laminated side and rear windows
- ★ Rectangular quartz halogen headlights
- ★ Styled steel road wheels and with these additional features which are not standard equipment on Escort GL:
- ★ Tinted side windows
- ★ Electric clock
- ★ Timber veneer fascia panel on dash
- ★ Tachometer and trip meter
- ★ Vanity mirror in passenger sun-visor

- ★ Vinyl roof
- ★ Front and rear bumper overriders
- ★ Styled left hand exterior rear view mirror
- ★ Carpeted floor in luggage compartment
- ★ Intermittent windscreen wipers



Ford Escort L & GL Sedans and Vans, and Ghia Sedan Options and Specifications (Options are at extra cost)

CONVENIENCE EQUIPMENT	Escort L	Escort GL	Escort Ghia	Escort Rec. Van
Integrated air conditioning	(a) NA	OPT	OPT	OPT
Styled left hand rear-view mirror	(b) OPT	OPT	STD	STD
Styled right hand remote control rear-view mirror	OPT	OPT	STD	OPT
AM push-button radio	OPT	STD	STD	STD
AM/FM Multiplex push-button radio	(c) OPT	OPT	OPT	NA
Towing pack	(d) OPT	OPT	OPT	OPT
Child harness	(e) OPT	OPT	OPT	NA
SPORTS EQUIPMENT				
GS Rally Pack	(c) (e) OPT	OPT	NA	NA
Tinted-band, laminated windscreen	OPT	OPT	STD	OPT
Long-range driving lights	(f) OPT	OPT	OPT	STD
Sports-handling suspension	(c) (g) NA	OPT	OPT	NA
Black front spoiler	(c) OPT	OPT	NA	NA
APPEARANCE EQUIPMENT				
Vinyl roof	(c) OPT	OPT	STD	NA
Bumper overrides	(c) (h) OPT	OPT	STD	NA

ENGINE AND TRANSMISSION COMBINATIONS	Escort L	Escort GL	Escort Ghia	Escort Rec. Van
1.6 litre crossflow "four" with: All-synchro, 4-speed manual floor shift	STD	STD	NA	STD
3-speed T-bar automatic floor shift	OPT	OPT	NA	OPT
2 litre crossflow "four" with: All-synchro, 4-speed manual floor shift	NA	OPT	STD	OPT
3-speed T-bar automatic floor shift	NA	OPT	OPT	OPT

WHEELS AND TYRES AVAILABILITY	Escort L	Escort GL	Escort Ghia	Escort Rec. Van
"Volante" sports alloy road wheels	(c) (i) OPT	OPT	OPT	OPT
Y78L 13 cross-ply tyres	(j) STD	NA	NA	NA
155 SR 13 radial ply tyres	STD	STD	NA	NA
ZR 78S 13 steel-belt radial ply tyres	(k) OPT	OPT	STD	NA
ZR 70S 13 steel-belt radial ply tyres	(c) (l) OPT	OPT	OPT	STD

DIMENSIONS	Sedan	Van
Overall length—with overriders	4059 mm (159.8")	4059 mm (159.8")
—without overriders	3978 mm (156.6")	3978 mm (156.6")
Overall width	1596 mm (62.8")	1565 mm (61.6")
Overall height	1373 mm (54.1")	1545 mm (60.8")
Wheelbase	2405 mm (94.7")	2405 mm (94.7")
Track—front	1270 mm (50.0")	1270 mm (50.0")
—rear	1296 mm (51.0")	1296 mm (51.0")
Fuel tank capacity	54.6 ltrs (12 gals)	54.6 ltrs (12 gals)
Luggage capacity—maximum	0.34 m ³ (11.9 ft ³)	NA
Turning circle—curb	8.9 m (29.2 ft)	8.9 m (29.2 ft)

ENGINE SPECIFICATIONS	1.6 litre Manual/Auto	2 litre Manual/Auto
Engine displacement (cc)	1598	1998
Bore (mm)	81.0	90.8
Stroke (mm)	77.6	76.9
Compression ratio (to 1)	8.0:1	9.2:1 8.2:1
Max power (DIN)	46 kw (61 hp) at 5000 rpm	70 kw (94 hp) at 5200 rpm
Max torque (DIN)	110 Nm (81 lb ft) at 2500 rpm	148 Nm (109 lb ft) at 3800 rpm
		140 Nm (103 lb ft) at 3500 rpm

STD means standard equipment
OPT means optional at extra cost
NA means not available on this model

Always discuss your intended purchase carefully with your Ford Dealer before placing your order.

Please note: All measurements, dimensions and capacities referred to above are approximate only.

Footnotes to charts on left:

- (a) Air conditioning is available only with the 2 litre engine and includes tinted side and rear glass as standard.
(b) Standard on L and GL vans.
(c) Not available on vans.
(d) Towing pack includes tow bar, gooseneck, wiring and heavy-duty flasher unit. Towing capacity of up to 545 kg (1200 lbs) GTW.
(e) GS Rally Pack comprises: Black-finish driving lights, front and rear bumper overrides, black quarter front bumpers, black rear bumper, black bodyside tape stripes, sports steering wheel, tachometer, black paint treatment, black-finish right hand and left hand exterior mirrors, black rear decklid spoiler, intermittent windshield wipers and styled steel wheels. (Please note that bodyside protection mouldings are not available when GS Rally Pack is specified.) Exterior paint range is restricted to: Satin Spruce, Modena Green, Platinum Blue, Desert Haze, Sweet Cream, Raw Orange, Pine 'n' Lime, Red Flame and Sno White.
(f) Long range driving lights are standard with Rally Pack. Front bumper overrides are also standard with this option.
(g) Sports-handling suspension is available only with 2 litre engine sedans. Comprises: Stiffer spring and shock-absorber settings, increased diameter front anti-roll bar and addition of rear anti-roll bar.
(h) Bumper overrides are standard with Rally Pack and with the Driving Lights option.
(i) Steel-belt radial tyres must be specified with "Volante" sports alloy road wheels.
(j) Y78L 13 cross-ply tyres are standard on Escort L Van only and are not available on any other model.
(k) ZR 78S 13 steel-belt radials are fitted as standard to 2 litre models and are optional at extra cost on 1.6 litre models.
(l) ZR 70S 13 steel-belt radials are optional at extra cost on 1.6 and 2 litre models.

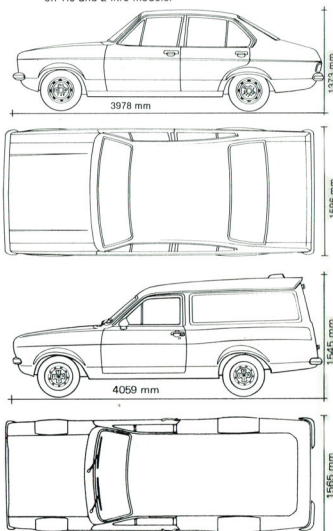

Illustrated above: Ford Cortina GL Sedan with optional GS Rally Pack (available at extra cost).

Ford Cortina.
Drive it . . . it makes
beautiful sense.



Interior shown with optional T-bar automatic (available at extra cost)

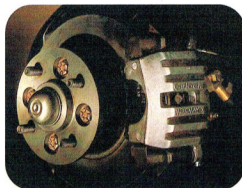

FORD CORTINA L

Everyone these days has a keen sense for value. And one sure way to bring it right out into the open is to get behind the wheel of a Cortina L. Here is neatly tailored simplicity in a size for today's out-and-about living. Beautifully compact on the outside for light responsive manoeuvring. Yet spacious and comfortably appointed inside, with a list of equipment that may be considered luxurious by some, but it simply makes beautiful sense. Particularly when you consider Cortina L's price-tag.

FORD CORTINA L STANDARD EQUIPMENT HIGHLIGHTS:

- ★ Steel, slotted road wheels
- ★ Steel belt radial-ply tyres
- ★ Reclining front bucket seats
- ★ Perforated vinyl upholstery

- ★ Inertia reel front seat belts
- ★ Loop-pile carpeting
- ★ Directional, power-boosted ventilation
- ★ Styled, right-hand-side exterior rear-view mirror
- ★ Quartz-halogen headlights
- ★ Deep-section bumper bars with protective rubber end caps
- ★ Interior courtesy lights operated by front doors
- ★ 3-speed heater/demister
- ★ Lockable glove box
- ★ Cigar lighter (illuminated)
- ★ Prismatic day/night rear-view mirror
- ★ Black, non-glare windscreen wipers
- ★ Front fender side-marker lights
- ★ Steering column control stalks for
 - (i) turn signal/lane change, high/low beam, headlight flasher and horn
 - (ii) windscreen wash/wipe



FORD CORTINA GL

A car that's beautiful to look at and to drive is all very well, but there's more to motoring than looking good and feeling good behind the wheel.

A very big consideration with the Cortina GL is its comprehensive feature level.

It packs as much room, comfort, riding-quality and performance into its clean, uncluttered lines as some cars costing considerably more. Handles and tracks beautifully. And has a long list of standard equipment.

Therefore, it lets you set your standards high – without you having to pay a high price.



FORD CORTINA GL STANDARD EQUIPMENT HIGHLIGHTS

As for Cortina L but with these upgraded features:

- ★ Steel sports-type wheels
 - ★ Interior courtesy lights operated by front and rear doors
- and with these additional features which are not standard equipment on Cortina L:
- ★ Front centre console
 - ★ Heated rear window demister
 - ★ AM push-button radio
 - ★ Electric clock
 - ★ Outboard passenger grab handles
 - ★ Rear seat folding centre armrest
 - ★ Bodyside protection mouldings

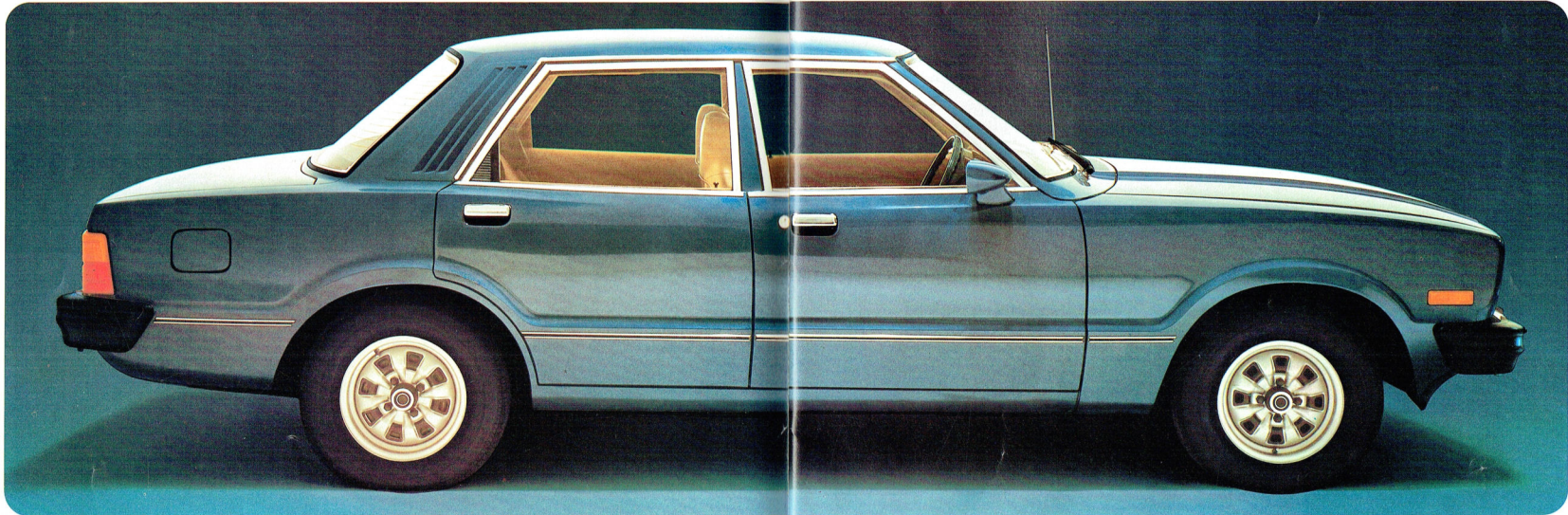

FORD CORTINA L and GL WAGONS

Versatile, strong and spacious . . . that sums up the Cortina Wagons. Whichever model you choose, L or GL, use it as a freedom machine . . . work-horse . . . shopping basket . . . delivering the kids . . . or whatever. It offers you a lot of loadspace. A rear opening that's wide and deep. And a tailgate that swings up in one easy action.

It offers you the same manoeuvrability of the Cortina sedans, too. The same tight turning circle. The same variable-ratio rack-and-pinion steering, power-assisted brakes and wide track for relaxation behind the wheel. And the great ride benefits of variable-rate rear springs. Combine those attributes with its list of standard appointments and you begin to get the idea it's in a class of its own. And you're right.

FORD CORTINA L WAGON STANDARD EQUIPMENT HIGHLIGHTS:

- ★ Steel, slotted road wheels
- ★ Steel-belt radial ply tyres
- ★ Reclining front bucket seats
- ★ Perforated vinyl upholstery
- ★ Loop-pile carpeting—front and rear passenger compartments
- ★ Directional, power-assisted ventilation
- ★ Styled, right-hand side exterior rear-view mirror

- ★ Quartz halogen headlights
- ★ Deep-section bumper bars with protective rubber end caps
- ★ Interior courtesy lights operated by front doors
- ★ 3-speed heater/demister
- ★ Lockable glove box
- ★ Cigar lighter (illuminated)
- ★ Prismatic day/night rear-view mirror
- ★ Black, non-glare windscreen wipers
- ★ Front fender side-marker lights
- ★ Steering column control stalks for
 - (i) Turn signal/lane change, high/low beam, headlight flasher and horn
 - (ii) Windscreen wash/wipe

FORD CORTINA GL WAGON STANDARD EQUIPMENT HIGHLIGHTS:

As for Cortina L Wagon but with these upgraded features:

- ★ Styled sports-type road wheels
- ★ Carpet in load area
- And with these additional features which are not standard equipment on Cortina L Wagon:
 - ★ Body-side protection mouldings
 - ★ Rear window wash/wipe
 - ★ Front centre console
 - ★ AM push button radio
 - ★ Electric clock
 - ★ Outboard passenger grab handles front and rear

Illustrated below: Cortina GL interior with optional AM/FM Multiplex Radio and Cassette Player (available at extra cost).

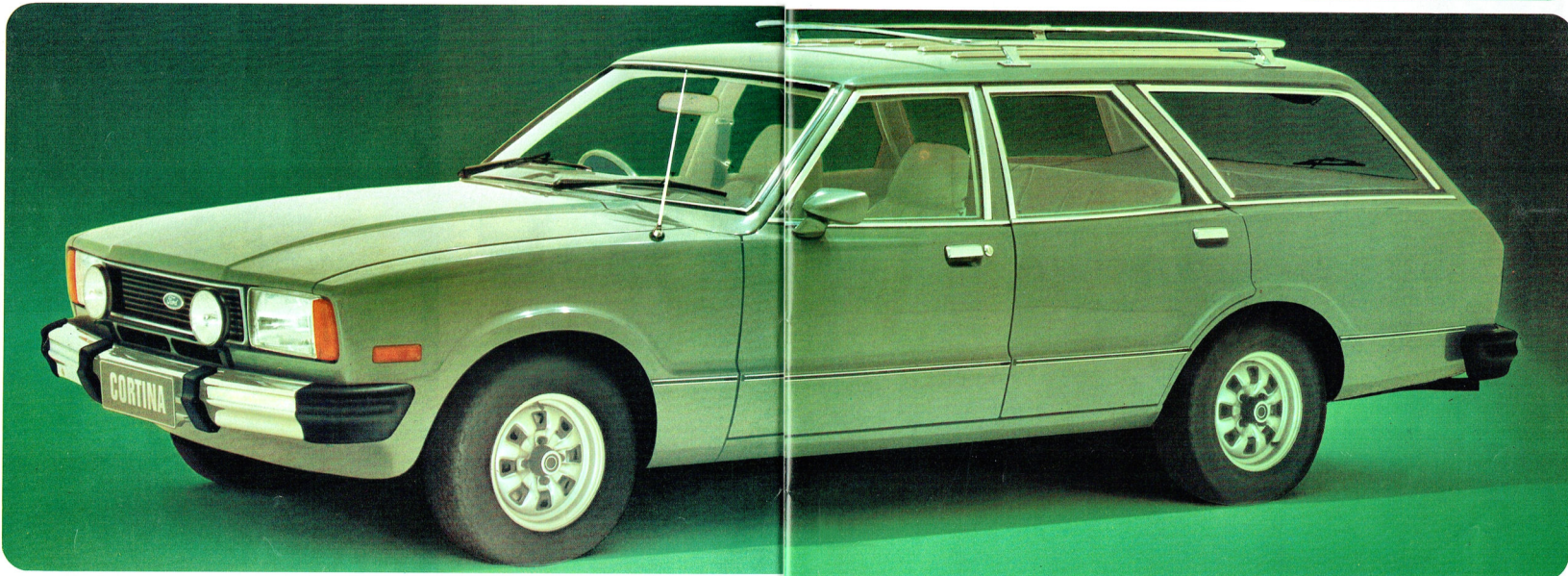
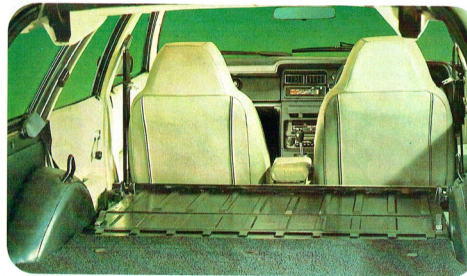

Illustrated above: Ford Cortina GL Wagon with optional Luxury Pack (available at extra cost).

FORD CORTINA GHIA

The Cortina Ghia is the top-of-the-line Cortina. Marked by distinctive exterior styling touches, such as vinyl roof and European full-alloy, wide-rim wheels, it also features a luxurious interior. Tastefully upholstered with rich cord and cashmere-knit fabrics, the Ghia gives you deeply-cushioned, body-contoured seating, thick, cut-pile carpeting and extensive sound-insulation. The ride is smooth—and with the added grip of steel-belt radial ply tyres. Order it as a 'four' or a 'six' with your choice of console-mounted manual shift as standard, or optional at extra cost T-bar automatic.

FORD CORTINA GHIA STANDARD EQUIPMENT HIGHLIGHTS:

As for Cortina GL but with these upgraded features:

- ★ 4-spoke 'soft-feel' steering wheel
- ★ Thick, cut-pile carpeting
- ★ Intermittent windscreen wipers
- ★ Remote-control exterior rear-view mirror on driver's side
- ★ Outboard inertia reel rear seat belts

And with these additional features which are not standard on Cortina GL:

- ★ Vinyl roof
- ★ Tinted-band, laminated windscreen
- ★ Tinted side and rear glass
- ★ Tachometer, oil gauge and trip meter
- ★ Styled, left-hand side exterior rear-view mirror
- ★ Map pockets in rear of seats
- ★ Deep-section body-side protection mouldings



Interior shown with optional T-Bar automatic (available at extra cost).

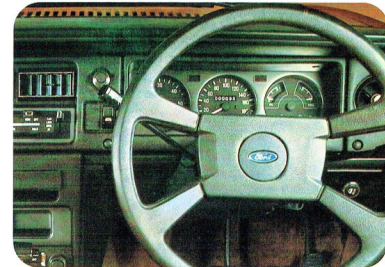



Vehicles illustrated above and below have optional steel belt radials (available at extra cost).

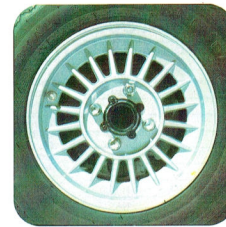

FORD CORTINA GS RALLY PACK OPTION

Available at extra cost on L and GL models

The GS Rally Pack is designed to allow you to drive your own Grand Sport touring car... to make your Cortina into a sporty-looking, sports-handling machine.

All you do is pick your model... Cortina L or GL... 'six' or 'four'... sedan or wagon. Then add the GS Pack and exciting things happen.

Along the side, bold body-side tape stripes. Black paint treatment at the front and rear, and around the windscreen and rear window. Black-finish bumper bars with protective rubber overrides. Full alloy 'Volante' sports road wheels.

Up front there are twin, long-range halogen driving lights, also black-finish to merge in with the grille.

Inside, there's the European 4-spoke 'soft feel' steering wheel (shown below) and comprehensive instrumentation, including tachometer, trip meter and oil gauge.

At your finger tips, there's the control stalk for intermittent windscreen wipers and washer. And, in sedans, a heavy duty sports-handling suspension with increased diameter anti-roll bars and performance-tuned shock absorber valving.

Even the range of colours available with the GS Pack is designed to make you feel a little special. They're limited to the bolder,

more vibrant colours so that your 'Cortina GS' will be a reflection of the way you are.

OTHER CORTINA OPTIONS INCLUDE:
Integrated air conditioning lets you travel in climate-controlled comfort throughout the year. Dehumidifies the air, too. Available on all Cortina models.

GL comfort/convenience pack available with the GL Sedan. Consists of driver's side remote-control exterior rear-view mirror, passenger's side exterior rear-view mirror, rear-seat inertia-reel seat belts and 'Houndstooth' cloth trim seat-facings.

GL luxury pack available with GL Sedan and Wagon. For the sedan it consists of all GL 'Comfort/Convenience Pack' items above, plus: Cassette player, long range driving lights, front and rear bumper overrides and run roof. For the GL wagon, it consists of driver's side remote-control rear-view mirror, passenger's side rear-view mirror, cassette player, long range driving lights, front and rear bumper overrides and chrome roof rack.

Power steering reduces steering effort, for ease-of-parking. Variable ratio steering geometry gives good response and requires only 3.2 turns lock-to-lock. (Available with 6-cylinder models only.)

Illustrated below: Ford Cortina GL '4' interior with optional GS Rally Pack and Cassette Player (available at extra cost).

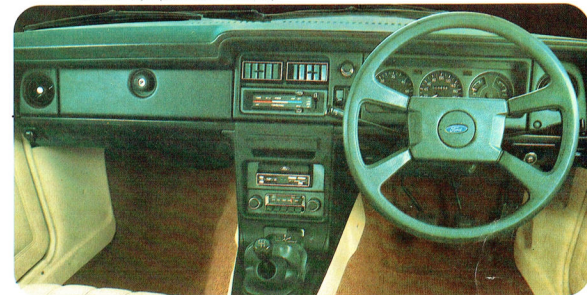

Ford Cortina L, GL and Ghia Options and Specifications

CONVENIENCE EQUIPMENT	Cortina L Sedan	Cortina L Wagon	Cortina GL Sedan	Cortina GL Wagon	Cortina Ghia
Integrated air conditioning	(a) OPT	OPT	OPT	OPT	OPT
AM push-button radio	OPT	OPT	STD	STD	STD
AM/FM Multiplex push-button radio	OPT	OPT	OPT	OPT	OPT
Cassette player	NA	NA	OPT	OPT	OPT
Sliding steel sun roof	OPT	NA	OPT	NA	OPT
Left hand side exterior rear-view mirror	OPT	OPT	OPT	OPT	STD
GL Comfort/Convenience Pack	(b) NA	NA	OPT	NA	NA
GL Luxury Pack	(c) NA	NA	OPT	OPT	NA
Ghia Prestige Pack	(d) NA	NA	NA	NA	OPT
Class I Towing Pack	(e) OPT	OPT	OPT	OPT	OPT
Child harness	OPT	OPT	OPT	OPT	OPT
SPORTS EQUIPMENT					
GS Rally Pack	(f) OPT	OPT	OPT	OPT	NA
Tinted-band laminated windshield	OPT	OPT	OPT	OPT	STD
Long range driving lights	(g) OPT	OPT	OPT	OPT	OPT
Power steering	(h) OPT	OPT	OPT	OPT	OPT
APPEARANCE EQUIPMENT					
Vinyl roof	OPT	NA	OPT	NA	STD
Bodyside protection moulding	(i) OPT	OPT	STD	STD	NA
Bumper rub strips and overriders	(j) OPT	OPT	OPT	OPT	STD

ENGINE/TRANSMISSION COMBINATIONS						
		CORTINA L		CORTINA GL		Ghia
		Sedan	Wagon	Sedan	Wagon	Sedan
FOUR-CYLINDER MODELS						
2 litre 4" with:	4-speed manual, floorshift	STD	STD	STD	STD	STD
	3-speed T-Bar, automatic	OPT	OPT	OPT	OPT	OPT
SIX-CYLINDER MODELS						
		CORTINA L		CORTINA GL		Ghia
		Sedan	Wagon	Sedan	Wagon	Sedan
3.3 litre 6" with:	3-speed manual, floorshift	STD	STD	STD	STD	NA
	3-speed T-Bar, automatic	OPT	OPT	OPT	OPT	NA
4.1 litre 6" with:	4-speed manual, floorshift	OPT	OPT	OPT	OPT	STD
	3-speed T-Bar, automatic	OPT	OPT	OPT	OPT	OPT

WHEELS AND TYRES AVAILABILITY	Cortina L Sedan	Cortina L Wagon	Cortina GL Sedan	Cortina GL Wagon	Cortina Ghia Sedan
Argent steel slotted road wheels	STD	STD	NA	NA	NA
Steel sports-type road wheels	NA	NA	STD	STD	NA
European full-alloy road wheels	NA	NA	NA	NA	STD
Volante sports alloy road wheels (available only as part of GS Rally Pack)	OPT	OPT	OPT	OPT	NA
BR 78S 13 steel belt radials	STD	STD	STD	STD	STD
BR 70H 13 steel belt radials	OPT	OPT	OPT	OPT	OPT

DIMENSIONS	Sedan		Wagon	
Overall length—without overriders	4376 mm (172.3")	4493 mm (176.9")	4493 mm (174.5")	4544 mm (178.9")
—with overriders	4433 mm (174.5")	4544 mm (178.9")	4544 mm (178.9")	4595 mm (180.9")
Overall width	1699 mm (66.9")	1699 mm (66.9")	1699 mm (66.9")	1699 mm (66.9")
Overall height	1333 mm (52.5")	1342 mm (52.8")	1342 mm (52.8")	1342 mm (52.8")
Wheelbase	2578 mm (101.5")	2578 mm (101.5")	2578 mm (101.5")	2578 mm (101.5")
Track—front and rear	1426 mm (56.1")	1426 mm (56.1")	1426 mm (56.1")	1426 mm (56.1")
Fuel tank capacity	55 litres (12.1 gals)	55 litres (12.1 gals)	55 litres (12.1 gals)	55 litres (12.1 gals)
Turning circle (wheel centreline)	10.4 m (34 ft.)	10.4 m (34 ft.)	10.4 m (34 ft.)	10.4 m (34 ft.)
Luggage capacity (maximum)	0.33 m ³ (11.8 cu. ft.)	0.33 m ³ (11.8 cu. ft.)	0.33 m ³ (11.8 cu. ft.)	0.33 m ³ (11.8 cu. ft.)
Wagon load capacity—to rear seat	0.96 m ³ (34 cu. ft.)	0.96 m ³ (34 cu. ft.)	0.96 m ³ (34 cu. ft.)	0.96 m ³ (34 cu. ft.)
—to front seat (with rear seat folded down)	1.81 m ³ (64 cu. ft.)	1.81 m ³ (64 cu. ft.)	1.81 m ³ (64 cu. ft.)	1.81 m ³ (64 cu. ft.)

Please note: All measurements, dimensions and capacities referred to above are approximate only.

ENGINE SPECIFICATIONS	2.0 litre 4-cylinder Manual	2.0 litre 4-cylinder Auto	3.3 litre 6-cylinder	4.1 litre 6-cylinder
Engine displacement (cc)	1998	1998	3280	4100
Bore (mm)	90.8	90.8	93.5	93.5
Stroke (mm)	76.9	76.9	79.1	99.3
Compression ratio (to 1)	9.2	8.2	7.9	9.0

Always discuss your intended purchase carefully with your Ford Dealer before placing your order.

(Options are at extra cost)

- Footnotes to chart on left:**
- (a) Tinted side and rear glass is standard when air conditioning is specified. Tinted rear liftgate window is not available on Cortina L wagon. Air conditioning is standard with Prestige Pack.
 - (b) GL Comfort/Convenience Pack is available on GL Sedan only. Consists of right hand side remote-control exterior rear-view mirror, left hand side exterior rear-view mirror, rear seat inertia-reel seat belts and 'Houndstooth' cloth trim seat-lacings.
 - (c) GL Luxury Pack is available on GL Sedan and Wagon only. For the Sedan it consists of all GL 'Comfort/Convenience Pack' items above, plus: Cassette player, long-range driving lights, front and rear bumper overriders and sun roof. For the GL wagon it consists of right hand side remote-control exterior rear-view mirror, passenger side exterior rear-view mirror, cassette player, driving lights, front and rear bumper overriders and chrome roof rack.
 - (d) The Ghia Prestige Pack consists of sun roof, cassette player, integrated air conditioning and power steering. Available only with 6-cylinder engines.
 - (e) Class I Towing Pack comprises tow bar, gooseneck, wiring, revised flasher unit and, on sedans only, heavy-duty sports suspension. Towing capacity of up to 907 kg (2000 lbs) G.T.W.
 - (f) GS Rally Pack comprises comprehensive instrumentation, 4-spoke 'soft foot' steering wheel, intermittent windshield wipers, body-side tape stripes, black-finish driving lights, bumper overriders, black paint treatment, 'Volante' sports alloy road wheels and sports-handling suspension (sedans only).
 - (g) Long range driving lights are standard with GL Luxury Pack. Front and rear overriders are standard with this option.
 - (h) Power steering available only with 6-cylinder engines.
 - (i) Bodyside protection mouldings are not available with GS Rally Pack. Deep section mouldings are standard on Cortina Ghia.
 - (j) Bumper rub strips and overriders are not available with GS Rally Pack. GL Luxury Pack or Long Range Driving Lights.
- STD means standard equipment.
OPT means optional at extra cost.
NA means not available for this model.

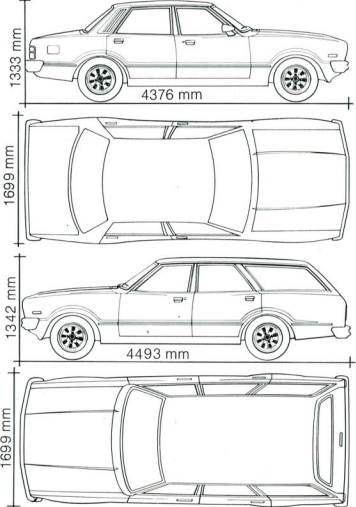

Ford Falcon The great Australian road car



Illustrated above: Ford Fairmont GXL Sedan with optional 4.9 V8 engine and FR70H steel belt radial tyres (available at extra cost).

FORD FALCON SEDAN AND WAGON

Deliver the goods with comfort, performance and style

Because it's for business it doesn't mean that a sedan or wagon can't be a pleasure to own and drive.

Falcon Sedans and Wagons go a long way to satisfy the needs of man, as well as the essential economic needs of the business.

Power: Emissionised, crossflow 6 cylinder engines that deliver great performance.

Economy: The 3.3 litre "six" does the job on money-saving standard grade petrol.

Automatic transmission option: For extra cost you can have the convenience of automatic transmission.

Braking power: Turbo-boosted, front power disc brakes are standard giving Falcon Sedan and Wagon real stopping power.

Comfort: There's flow-through, power-assisted ventilation. A deeply padded bench seat with centre armrest. The convenience of inertia reel seat belts for driver and front-seat passenger, and a great windscreen wiper/wash system, with an anti-lift vane fitted to the driver's side blade.



FORD FALCON SEDAN AND WAGON STANDARD EQUIPMENT HIGHLIGHTS

- ★ 3.3 litre crossflow head 6 cylinder engine
- ★ 3 speed column shift manual transmission
- ★ 7.75L 14 black sidewall tyres
- ★ Front bench seat with centre armrest
- ★ Outboard inertia reel front seat belts
- ★ Prismatic interior day/night rear view mirror
- ★ Power assisted ventilation
- ★ 3 speed heater/demister with illuminated controls
- ★ 2 speed windscreen wipers with anti-lift vane fitted to driver's side blade
- ★ 4 jet windscreen washers
- ★ Steering column control stalk for turn signal/lane change, high/low beam, headlight flasher and horn
- ★ Rubber floor mat in passenger compartment
- ★ Vinyl seat upholstery
- ★ Styled right hand exterior rear view mirror
- ★ Lockable passenger side glove compartment
- ★ Front passenger side parcel shelf and driver's side trinket tray
- ★ Rubber mat on luggage compartment floor (sedan only)

OPTIONS[†]

Make your Falcon a personal road car

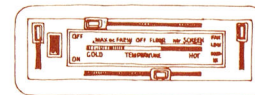
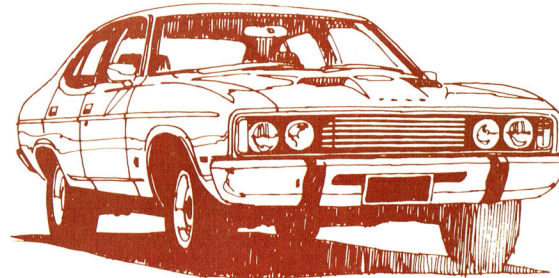

1.



2.

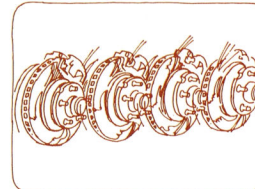

3.

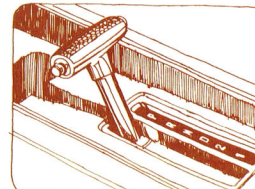

† Available at extra cost

4.

There are a number of options available at extra cost to make your Falcon more personal, more outstanding, a more exciting great road car.

The **GS Rally Pack^{*}**, illustrated above, is a way to make your Falcon 500 or Fairmont a sporty looking machine—with distinctive paint treatment; styled steel road wheels with trim rings; bonnet scoops; long range driving lights[†]; comprehensive instrumentation including tachometer, oil pressure, temperature and fuel gauges, speedometer with odometer, plus electric clock; "soft-feel" sports steering wheel and map reading light. ^{*}Please note: The GS Rally Pack is not available on Hardtop models or Fairmont GXL, and the long range driving lights are not available on Fairmont models.

1. **Integrated air conditioning** lets you travel in climate-controlled comfort throughout the year. Dehumidifies the air, too.
2. **AM/FM Multiplex push-button radio** provides two channel FM stereophonic sound from two front speakers.
3. **Four-wheel power disc brakes** are designed to provide optimum braking.
4. **Automatic transmission** is available in two forms; with column-mounted shift lever or sporty T-Bar form, as illustrated.
5. **A sliding steel sunroof** lets the sun shine in, or the moon. Helps make driving your Falcon even more of a pleasure.

For full details of options availability for Ford Falcon, Falcon 500 and Fairmont models, turn to pages 36 & 37.

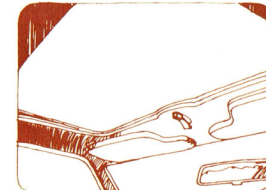

5.

FORD FALCON 500 SEDAN

A great Australian road car

In road handling, performance and driver comfort, Ford Falcon 500 has earned a reputation over the years as a great Australian road car.

And today's Falcon keeps that reputation driving along with performance and comfort features to make it even greater.

Size it up for power and you'll find that the Falcon six cylinder crossflow head engine delivers great performance whilst using standard grade fuel.

Size it up for comfort including reclining front bucket seats in soft "Mystique" grain vinyl.

Size it up for convenience and value and you'll find a long list of standard features—such as AM push-button radio with lock-down aerial—that make Falcon 500 good value for money.

FORD FALCON 500 SEDAN STANDARD EQUIPMENT HIGHLIGHTS

- ★ 3.3 litre crossflow head 6 cylinder engine
- ★ 3 speed column shift manual transmission
- ★ Power front disc brakes
- ★ Radial ply tyres
- ★ AM push-button radio with lock-down aerial
- ★ Reclining front bucket seats
- ★ Outboard inertia reel front seat belts
- ★ Prismatic day/night interior rear view mirror
- ★ Power assisted ventilation
- ★ 3 speed heater/demister with illuminated controls
- ★ 2 speed windscreen wipers with anti-lift vane fitted to driver's side blade
- ★ 4 jet windscreen washers

- ★ Steering column control stalk for turn signal/lane change, high/low beam, headlight flasher and horn
- ★ Loop pile carpeting
- ★ "Mystique" grain vinyl seat upholstery
- ★ Styled right hand exterior rear view mirror
- ★ Interior courtesy light operated by front doors
- ★ Lockable front passenger side glove box
- ★ Front passenger side parcel shelf and driver's side trunket tray
- ★ Quartz halogen headlights
- ★ Electric rear window demister
- ★ Cigarette lighter built into front centre ashtray
- ★ Bodyside protection mouldings
- ★ Folding centre armrest in front compartment



Illustrated above: Ford Falcon 500 with optional 4.1 litre engine and automatic transmission (available at extra cost).



FORD FALCON 500 & FAIRMONT WAGONS

Big Wagons ... loaded with comfort and features

Falcon 500 and Fairmont Wagons are year-round propositions – for shopping, family trips or holidays. Both treat you to the similar comfort features of their respective sedans ... with the added advantage of a large loadspace.

Fairmont Wagon has two other big loading advantages. A "Dual Action" tailgate which opens like a door or lowers like a conventional tailgate, and an integrated, chrome-finish roof rack. The "Dual Action" tailgate is also available at extra cost on Falcon 500 Wagon. A folding rear-facing third seat for two children in the load area is available at extra cost on all Falcon Wagons.

And both Falcon 500 Wagon and Fairmont Wagon have engineised engines that deliver great performance. The standard engine in Falcon 500 Wagon is the 3.3 litre "six" while Fairmont Wagon has the 4.1 litre "six"

FORD FALCON 500 WAGON STANDARD EQUIPMENT HIGHLIGHTS

- ★ 3.3 litre crossflow head 6 cylinder engine
- ★ 3 speed column shift manual transmission
- ★ Power front disc brakes
- ★ 7.75 L 14 tyres
- ★ AM push-button radio with lock-down aerial
- ★ Reclining front bucket seats
- ★ Outboard inertia reel front seat belts
- ★ Prismatic day/night interior rear view mirror
- ★ Power assisted ventilation
- ★ 3 speed heater/demister with illuminated controls
- ★ 2 speed windscreen wipers with anti-lift vane fitted to driver's side blade
- ★ 4 jet windscreen washers
- ★ Steering column control stalk for turn signal/lane change, high/low beam, headlight flasher and horn
- ★ Loop pile carpeting
- ★ "Mystique" grain vinyl seat upholstery
- ★ Styled right hand exterior rear view mirror



- ★ Interior courtesy light operated by front doors
- ★ Lockable passenger side glove box
- ★ Front passenger side parcel shelf and driver's side trinket tray
- ★ Quartz halogen headlights
- ★ Cigarette lighter built into front centre ashtray
- ★ Bodyside protection mouldings
- ★ Folding centre armrest in front compartment



Illustrated above:
Falcon 500 Wagon with optional 4.1 litre engine (available at extra cost).

FORD FAIRMONT WAGON STANDARD EQUIPMENT HIGHLIGHTS

As for Falcon 500 Wagon but with these upgraded features:

- ★ 4.1 litre crossflow head 6 cylinder engine
- ★ 3 speed T-bar automatic transmission
- ★ Steel belt radial ply tyres
- ★ Intermittent action windscreen wipers with anti-lift vane fitted to driver's side blade
- ★ Cut pile carpeting
- ★ Styled remote control right hand exterior rear view mirror
- ★ Interior courtesy lights operated by all four doors
- ★ Rectangular quartz halogen headlights
- ★ Front centre console with armrest and storage bin
- ★ "Dual Action" tailgate

and with these additional features which are not standard equipment on Falcon 500 Wagon:

- ★ Electric clock
- ★ Carpeted floor in load area
- ★ Chrome finish roof rack



Illustrated above: Ford Fairmont Wagon with optional rear facing third seat (available at extra cost).



Illustrated above: Ford Fairmont Wagon with optional 4.9 litre V8 engine (available at extra cost).

FORD FALCON GS HARDTOP

Style on the bold side

If your style is on the bold side, Falcon GS spells it out in a striking, spirited way of travelling. And listed below is what makes Falcon GS Hardtop the bold one of the breed.



Illustrated above:
Foreground - Falcon GS Hardtop
Background - The car featured in the background is a specially prepared racing car not available from Ford Motor Company of Australia Limited.

FORD FALCON GS HARDTOP STANDARD EQUIPMENT HIGHLIGHTS

- ★ 4.1 litre crossflow head 6 cylinder engine
- ★ 4 speed floor shift manual transmission
- ★ Power front disc brakes
- ★ Radial ply tyres
- ★ AM push-button radio with lock-down aerial
- ★ Reclining front bucket seats
- ★ Outboard inertia reel front seat belts
- ★ Prismatic day/night interior rear view mirror
- ★ Power assisted ventilation
- ★ 3 speed heater/demister with illuminated controls
- ★ 2 speed windscreen wipers with anti-lift vane fitted to driver's side blade
- ★ 4 jet windscreen washers
- ★ Steering column control stalk for turn signal/lane change, high/low beam, headlight flasher and horn
- ★ Cut pile carpeting
- ★ "Houndstooth" pattern cloth seat upholstery

- ★ Styled right and left hand exterior rear view mirrors
- ★ Interior courtesy light operated by both doors
- ★ Lockable passenger side glove box
- ★ Front passenger side parcel shelf and driver's side trunket tray
- ★ Quartz halogen headlights
- ★ Electric rear window demister
- ★ Cigarette lighter built into front centre ashtray
- ★ Bodyside protection mouldings
- ★ Front centre console with armrest and storage bin
- ★ Slotted steel wheels with chrome finish trim rings
- ★ Front and rear bumper overrides
- ★ Comprehensive instrumentation including tachometer
- ★ Long range driving lights
- ★ Bonnet scoops
- ★ Rear quarter panel scoops
- ★ Distinctive paint treatment

FORD FAIRMONT HARDTOP

First-class Travel... Sporting style!

The Fairmont heritage of superbly appointed motoring... dramatically expressed in hardtop design. Smooth, powerful... a distinctive way to express good taste, with flair, in your driving style.

FORD FAIRMONT HARDTOP STANDARD EQUIPMENT HIGHLIGHTS

- As for Falcon GS Hardtop but with these upgraded features:
- ★ 3 speed T-bar automatic transmission
 - ★ Steel bell radial ply tyres
 - ★ Outboard inertia reel front and rear seat belts
 - ★ Intermittent action windscreen wipers with anti-lift vane fitted to driver's side blade
 - ★ Styled remote control right hand exterior rear view mirror



Illustrated above: Ford Fairmont Hardtop with optional manual transmission (available at reduced cost).

- ★ Rectangular quartz halogen headlights (driving lights are not available)
- ★ Variable ratio power steering
- ★ Alloy sports road wheels
- ★ Tinted-band, laminated windscreen.

and with these additional features which are not standard equipment on Falcon GS Hardtop:

- ★ Electric clock
- ★ Carpeted luggage compartment floor

Please note: Rear quarter panel scoops are not available on Fairmont Hardtop.



Illustrated above: Ford Fairmont Hardtop with optional 4.9 litre V8 engine (available at extra cost).

Page 32 Ford Fairmont Sedan

FORD FAIRMONT SEDAN**Quietly rewarding,
luxuriously satisfying**

Here's a highly appointed car with the power, strength and handling to take on just about everything Australia has to offer in road conditions. . . . with a distinguished all-round appearance that makes it recognisable in any business or social gathering.

Among the many standard features in Fairmont, you'll find beautifully contoured, reclining front bucket seats upholstered in soft grain vinyls . . . colour-keyed deep pile carpet . . . sports console with T-Bar automatic transmission . . . outboard inertia reel seat belts front and rear with concealed mechanisms . . . intermittent action windscreen wipers . . . electric rear window demister.

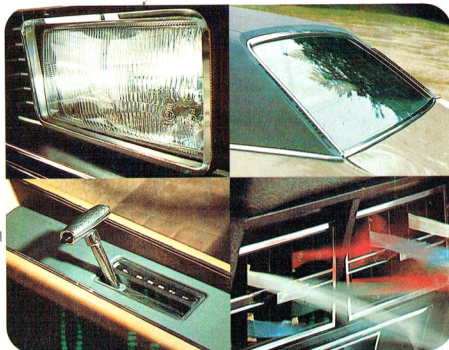
**FORD FAIRMONT SEDAN STANDARD
EQUIPMENT HIGHLIGHTS**

As for Falcon 500 Sedan but with these upgraded features:

- ★ 4.1 litre crossflow head 6 cylinder engine
- ★ 3 speed T-bar automatic transmission
- ★ Steel belt radial ply tyres
- ★ Outboard inertia reel front and rear seat belts
- ★ Intermittent action windscreen wipers with anti-lift vane fitted to driver's side blade
- ★ Cut pile carpeting
- ★ Styled remote control right hand exterior rear view mirror
- ★ Interior courtesy lights operated by all four doors
- ★ Rectangular quartz halogen headlights
- ★ Front centre console with armrest and storage bin

and with these additional features which are not standard equipment on Falcon 500 Sedan:

- ★ Electric clock
- ★ Carpeted luggage compartment floor
- ★ Folding centre armrest in rear compartment



Illustrated above: Ford Fairmont Sedan with optional vinyl roof, sports alloy road wheels and 4.9 litre V8 engine (available at extra cost).



FORD FAIRMONT GXL

The Australian personal sports sedan—in the European tradition

Fairmont GXL has the performance, handling and many of the comfort features you'd expect from a European style sports sedan . . . with a major difference . . . Fairmont GXL is designed and built in Australia for Australian conditions.

From start to finish, Fairmont GXL is a driver's car—equipped with a powerful "crossflow" head, 4.1 litre 6 cylinder engine, T-bar automatic transmission, power steering, 4 wheel power disc brakes, touring suspension, a limited slip differential, steel belted radials, alloy sports road wheels and quartz halogen headlights.



Illustrated above: Ford Fairmont GXL with optional vinyl roof and 5.8 litre engine (available at extra cost).



FORD FAIRMONT GXL STANDARD EQUIPMENT HIGHLIGHTS

As for Fairmont Sedan but with these upgraded features:

- ★ 4 wheel power disc brakes
- ★ Cord cloth seat upholstery
- ★ Limited slip differential
- ★ Touring suspension
- ★ Alloy sports road wheels
- ★ Tinted-band, laminated windscreen
- ★ "Soft-feel" steering wheel

and with these additional features which are not standard equipment on Fairmont Sedan:

- ★ Bonnet scoops
- ★ Front and rear bumper overriders
- ★ Front passenger side styled exterior rear view mirror
- ★ Front passenger side vanity mirror mounted in sun visor
- ★ Map pockets on rear of front seats
- ★ Comprehensive instrumentation including tachometer
- ★ Power steering



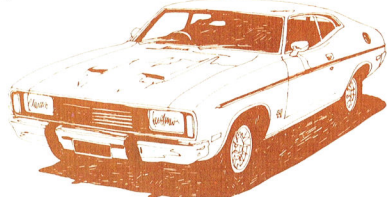

Ford Falcon, Falcon 500 and Fairmont Options

(available at extra cost)

CONVENIENCE EQUIPMENT	Falcon Sedan	Falcon Wagon	Falcon 500 Sedan	Falcon 500 Wagon	Falcon GS Hardtop	Fairmont Sedan	Fairmont Wagon	Fairmont Hardtop	Fairmont GXL
Integrated air conditioning	(a) OPT	OPT	OPT	OPT	OPT	OPT	OPT	OPT	OPT
AM push-button radio with lock-down aerial	OPT	OPT	STD	STD	STD	STD	STD	STD	STD
AM/FM Multiplex push-button radio with lock-down aerial	OPT	OPT	OPT	OPT	OPT	OPT	OPT	OPT	OPT
Stereo cassette tape player	OPT	OPT	OPT	OPT	OPT	OPT	OPT	OPT	OPT
Cloth seat upholstery—"Houndstooth" pattern	NA	NA	OPT	OPT	STD	OPT	OPT	STD	NA
Loop pile carpet	OPT	OPT	STD	STD	NA	NA	NA	NA	NA
Cut pile carpet	NA	NA	NA	NA	STD	STD	STD	STD	STD
Sun roof	(b) OPT	NA	OPT	NA	OPT	OPT	NA	OPT	OPT
Styled left hand exterior rear view mirror	(c) OPT	OPT	OPT	OPT	STD	OPT	OPT	STD	STD
Styled right hand remote control exterior rear view mirror	OPT	OPT	OPT	OPT	STD	STD	STD	STD	STD
Intermittent windshield wipers	OPT	OPT	OPT	OPT	STD	STD	STD	STD	STD
Bodyside protection mouldings	OPT	OPT	STD	STD	STD	STD	STD	STD	STD
Front and rear bumper overrides	OPT	OPT	OPT	OPT	STD	OPT	STD	STD	STD
Tinted side and rear glass	(d) OPT	OPT	OPT	OPT	OPT	OPT	OPT	OPT	OPT
Long range driving lights	(e) OPT	OPT	OPT	OPT	STD	NA	NA	NA	NA
Rear outboard inertia reel seat belts	OPT	NA	OPT	NA	OPT	STD	NA	STD	STD
Front bench seat	STD	STD	OPT	OPT	NA	NA	NA	NA	NA
Wagon third seat	NA	OPT	NA	OPT	NA	NA	OPT	NA	NA
Wagon "dual action" tailgate	NA	OPT	NA	OPT	NA	NA	STD	NA	NA
Wagon dust deflector	NA	OPT	NA	OPT	NA	NA	OPT	NA	NA

Footnotes to above chart:

- (a) Tinted side and rear glass is standard when air conditioning is specified.
Power steering is mandatory at extra cost when air conditioning is fitted with V8 engine.
(b) Vinyl roof is mandatory at extra cost when this option is specified.
(c) This option is standard when GS Rally Pack is specified.
(d) This option is standard when air conditioning is specified.
(e) Long range driving lights are standard when GS Rally Pack is specified on Falcon 500.

ENGINE AND TRANSMISSION COMBINATIONS	Falcon Sedan	Falcon Wagon	Falcon 500 Sedan	Falcon 500 Wagon	Falcon GS Hardtop	Fairmont Sedan	Fairmont Wagon	Fairmont Hardtop	Fairmont GXL
3.3 litre crossflow "six" with: All-synchro 3-speed manual column shift	(1) STD	STD	STD	STD	NA	NA	NA	NA	NA
3-speed automatic column shift	OPT	OPT	OPT	NA	NA	NA	NA	NA	NA
4.1 litre crossflow "six" with: All-synchro 3-speed manual column shift	(1) OPT	OPT	OPT	OPT	NA	NA	NA	NA	NA
All-synchro 4-speed manual floor shift	(2) NA	NA	OPT	OPT	STD	OPT	OPT	O/R	NA
3-speed automatic column shift	OPT	OPT	OPT	OPT	NA	OPT	OPT	NA	NA
3-speed T-bar automatic floor shift	(2) NA	NA	OPT	OPT	OPT	STD	STD	STD	STD
4.9 litre 4 barrel V8 with: All-synchro 4-speed manual floor shift	(3) (4) NA	NA	OPT	OPT	OPT	OPT	OPT	OPT	OPT
3-speed automatic column shift	OPT	OPT	OPT	OPT	NA	OPT	OPT	NA	NA
3-speed T-bar automatic floor shift	(2) NA	NA	OPT	OPT	OPT	OPT	OPT	OPT	OPT
GT POWER PACK OPTION 5.8 litre 4 barrel V8 with: All-synchro 4-speed manual floor shift	(3) (5) (2) NA	NA	OPT	NA	OPT	OPT	NA	OPT	OPT
3-speed automatic column shift	(2) NA	NA	OPT	OPT	NA	OPT	OPT	NA	NA
3-speed T-bar automatic floor shift	(2) NA	NA	OPT	OPT	OPT	OPT	OPT	OPT	OPT

Footnotes to above chart:

- (1) Power steering is not available with 3-speed manual column shift transmission.
(2) Sports console must be fitted with floor-mounted transmissions and is not available with bench seat.
(3) Power steering is mandatory at extra cost when air conditioning is fitted with V8 engines.
(4) Limited slip differential mandatory at extra cost with 4.9 litre V8 engine and manual transmission.
(5) Mandatory equipment, at extra cost, with the 5.8 litre engine: 4-wheel power disc brakes; limited slip differential; sports handling suspension or heavy duty suspension; FR70 H14 steel belt radial ply tyres.
Always discuss your intended purchase carefully with your Ford Dealer before placing your order.

POWER EQUIPMENT	Falcon Sedan	Falcon Wagon	Falcon 500 Sedan	Falcon 500 Wagon	Falcon GS Hardtop	Fairmont Sedan	Fairmont Wagon	Fairmont Hardtop	Fairmont GXL
4-wheel power disc brakes	(f) OPT	OPT	OPT	OPT	OPT	OPT	OPT	OPT	OPT
Variable ratio power steering	(g) OPT	OPT	OPT	OPT	OPT	OPT	OPT	STD	STD
Power operated tailgate window	NA	OPT	NA	OPT	NA	NA	OPT	NA	NA
Power operated windows	NA	NA	NA	NA	NA	OPT	OPT	OPT	OPT
HEAVY DUTY EQUIPMENT									
Outback package	(h) OPT	OPT	OPT	OPT	OPT	OPT	OPT	OPT	OPT
Heavy duty suspension	(i) OPT	OPT	OPT	OPT	OPT	OPT	OPT	OPT	OPT
Class I towing pack	OPT	OPT	OPT	OPT	OPT	OPT	OPT	OPT	OPT
Class II towing pack—without load distributing tow bar	(j) OPT	OPT	OPT	OPT	NA	OPT	NA	OPT	OPT
Class II towing pack—with load distributing tow bar	(j) OPT	OPT	OPT	OPT	NA	OPT	NA	OPT	OPT
SPORTS EQUIPMENT									
GS Rally Pack	(k) NA	NA	OPT	OPT	STD	OPT	OPT	NA	NA
Tinted-band, laminated windscreen	OPT	OPT	OPT	OPT	OPT	OPT	OPT	STD	STD
Sports alloy road wheels	OPT	OPT	OPT	OPT	OPT	OPT	OPT	STD	STD
Dual exhaust system	(l) OPT	NA	OPT	NA	OPT	NA	OPT	OPT	OPT
Limited slip differential	(m) OPT	OPT	OPT	OPT	OPT	OPT	OPT	OPT	STD
Sports handling suspension	(n) OPT	NA	OPT	NA	OPT	NA	OPT	NA	OPT
Long range fuel tank—118 litres (26 gallons)	OPT	NA	OPT	NA	OPT	OPT	NA	OPT	OPT
APPEARANCE EQUIPMENT									
Wheel covers	(o) OPT	OPT	OPT	OPT	NA	STD	STD	NA	NA
Vinyl roof	OPT	NA	OPT	NA	OPT	NA	OPT	NA	OPT
White roof (Tunone paint)	OPT	OPT	OPT	OPT	OPT	OPT	OPT	OPT	OPT

Footnotes to above chart:

- (f) 4-wheel disc brakes are optional at extra cost with 4.9 litre V8 engine and mandatory at extra cost with 5.8 litre V8 engine.
(g) This option is not available with 3-speed manual column shift transmission.
(h) Outback package consists of heavy duty shock absorbers and springs, increased diameter stabiliser bar, engine stone guard and heavy duty air cleaner.
(i) Heavy duty suspension is included in the outback package option and the Class II towing pack options.
(j) This option is only available with V8 engines and automatic transmission.
(k) GS Rally Pack includes: Distinctive paint treatment; slotted steel road wheels; bonnet scoops; comprehensive instrumentation including tach, oil pressure, temperature and fuel gauges; bumper overrides; electric clock (where not standard equipment); speedometer and odometer.
(l) This option is available at extra cost only with 4.9 litre and 5.8 litre V8 engines.
(m) This option is not available with 3.3 litre 6-cylinder engine; mandatory at extra cost with 4.9 litre V8 engine and manual transmission; mandatory at extra cost with 4-wheel power disc brakes and mandatory at extra cost with the 5.8 litre engine.
(n) Sports handling suspension is available at extra cost with 4.9 litre V8 engine and only available with 4-wheel disc brakes and limited slip differential. It is standard on Fairmont GXL but heavy duty suspension is standard when Class II Towing Pack or Outback Pack is specified.
(o) Wheel covers are not available with GS Rally Pack or Sports Road Wheels.

TYRES AND WHEELS	Falcon Sedan	Falcon Wagon	Falcon 500 Sedan	Falcon 500 Wagon	Falcon GS Hardtop	Fairmont Sedan	Fairmont Wagon	Fairmont Hardtop	Fairmont GXL
7.75 L14 Crossply tyres	STD	STD	NA	STD	NA	NA	NA	NA	NA
185 SR14 Textile radials	OPT	NA	STD	NA	STD	NA	NA	NA	NA
FR78 S14 Steel belt radials	OPT	NA	OPT	NA	OPT	STD	NA	STD	NA
FR78 S14 Steel belt radials	OPT	OPT	OPT	OPT	OPT	OPT	STD	OPT	STD
FR70 H14 Steel belt radials	OPT	OPT	OPT	OPT	OPT	OPT	OPT	OPT	OPT

CLASS I TOWING PACK

- Capable of towing up to 907 kgs (2000 lbs).
- Consists of:
Tow bar
Chrome gooseneck
Up-rated flasher unit and electricals.

CLASS II TOWING PACK WITH LOAD DISTRIBUTING TOW BAR (CODE 82)

- Capable of towing between 907 and 1587 kgs (2000 and 3500 lbs).
- Consists of:
Body re-inforcements
Heavy duty suspension
Heavy duty cooling package
Up-rated flasher unit and electricals
A load distribution hitch (insert bar with towing head, including ball, is separately available as an extra cost option from the dealer to suit individual customer towing requirements).

Trailer coupling, drawbar and towball are not supplied.

CLASS II TOWING PACK WITHOUT LOAD DISTRIBUTING TOW BAR (CODE 21)

- Capable of towing between 907 and 1587 kgs (2000 and 3500 lbs).
- Consists of:
Body re-inforcements
Heavy duty suspension
Heavy duty cooling package
Up-rated flasher unit and electricals

Ford Falcon, Falcon 500 and Fairmont Specifications

Dimensions:	Sedan	Wagon	Hardtop
Overall Length	4865 mm (191.5")	5078 mm (199.9")	4865 mm (191.5")
Overall Width	1900 mm (74.8")	1900 mm (74.8")	1968 mm (77.5")
Overall Height	1384 mm (54.5")	1414 mm (55.7")	1415 mm (55.7")
Wheelbase	2818 mm (111.0")	2946 mm (116.0")	2818 mm (111.0")
Track - front	1539 mm (60.6")	1539 mm (60.6")	1539 mm (60.6")
- rear	1527 mm (60.1")	1527 mm (60.1")	1527 mm (60.1")
Fuel tank capacity	79.5 litres (17.5 gallons)	72.7 litres (16.0 gallons)	79.5 litres (17.5 gallons)
Optional long range fuel tank capacity	120.5 litres (26.5 gallons)	NA	120.5 litres (26.5 gallons)
Turning circle - normal	12 m (39.4')	12.6 m (41.2')	12 m (39.4')
- with power steering	12.8 m (42.0')	12.9 m (42.4')	12.8 m (42.0')

Please note: All measurements, dimensions and capacities referred to above are approximate only.

Engine Specifications:	3.3 litre 6 cylinder	4.1 litre 6 cylinder	4.9 litre 8 cylinder	5.8 litre 8 cylinder
Engine displacement (cc)	3280	4100	4900	5800
Bore (mm)	93.5	93.5	101.6	101.6
Stroke (mm)	79.5	99.3	76.2	88.9
Compression ratio (to 1)	7.9	9.0	9.2	8.9

Driver and passenger protection:

The following items are built-in to all Falcon and Fairmont models to lessen the likelihood of an accident occurring—and to help prevent personal injury in the event of an accident:

- ★ Seat belts: Front outboard inertia reel seat belts (with front bench seat—2 lap sash, 1 lap front and rear; with front bucket seats—2 lap sash front, 2 lap sash, 1 lap rear) ★ Power front disc brakes ★ High-backed front seats
- ★ Recessed instrument panel with padded upper dash ★ Windscreen mounted breakaway, anti-glare interior rear view mirror ★ 3-speed heater/demister ★ 3 speed power assisted ventilation ★ Steering column designed to collapse at a predetermined load under impact conditions
- ★ Impact-absorbing steering wheel with padded hub ★ Controlled collapsible front end ★ Padded sun-visors ★ Padded door-pull armrests
- ★ 2 speed electric windscreen wipers (intermittent action on Fairmont and Fairmont GXL) ★ Non-reflective wiper blades with anti-lift vane fitted to driver's side blade ★ Zone-toughened windscreen and "safety glass" all other windows
- ★ Dual hydraulic brake system with brake proportioning valve and warning light ★ Driver's side exterior rear view mirror ★ "Safety-rim" wheels ★ Reversing lights ★ Front side marker lamps ★ Wrap-around rear turn lights (sedan only) ★ Flush-mounted exterior door handles
- ★ Side impact/intrusion bars

Servicing and Maintenance

After the initial 1500 km servicing, your new Ford will only require routine servicing every 10,000 km under normal driving and operating conditions. Ask your authorised Ford Dealer to advise you on service requirements for abnormal driving and operating conditions.

Always discuss your intended purchase carefully with your Ford Dealer before placing your order.

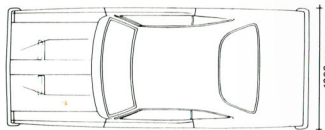
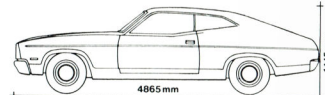
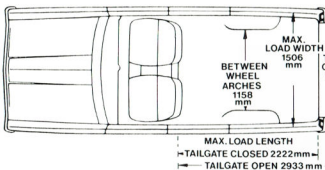
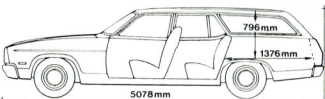
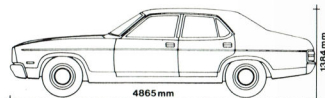

Ford Recreational Vehicles.

You're at home on the road.





Open up a Sundowner. The cruisin' Van from Ford.

Ford Falcon Sundowner—a van that's right-on when it comes to a combination of performance, strength, room, handling and versatility.

Best news of all though is up back—with the easy 'swing-up/drop-down' lift-gate tail-gate. Inside there's a flat steel-ribbed floor that's over 5 feet (1544 mm) wide and is 7 feet (2133 mm) long to the back of the front seats—covered with a rubber floor mat.

Sundowner gives you bold, good looks, too. Colourful stripes and Sundowner decals. Bonnet scoops. Blacked-out grille with a set of long range quartz halogen driving lights. For your comfort up front, there are reclining bucket seats and cut-pile carpet. A sporty console with armrest and storage bin. Comprehensive instrumentation includes tachometer, oil and temperature gauges. Then there's the soft-rim sports steering wheel and column stalk-control for turn indicators, lane-change, hi-lo beam, headlight flashers and horn button.

Illustrated below: Sundowner interior with optional AM/FM Multiplex push-button radio and Cassette Player (available at extra cost).



Sundowner.
You're at home on the road.

FORD FALCON SUNDOWNER STANDARD EQUIPMENT HIGHLIGHTS

As for Falcon 500 Van but with these upgraded features:

- ★ 4.1 litre (250 CID) cross-flow head 6-cylinder engine
- ★ 4-speed floor-shift manual transmission
- ★ ER70H steel-belt radial ply tyres
- ★ Comprehensive instrumentation including tachometer, oil and temperature gauges
- ★ Front centre console with armrest and storage bin
- ★ Soft-rim sports steering wheel
- ★ Passenger compartment cut-pile carpeting
- ★ Slotted steel sports wheels with chrome finish rings
- ... plus these additional features which are not standard equipment on Falcon 500 Van:
 - ★ Long-range quartz halogen driving lights
 - ★ Distinctive exterior stripes and 'Sundowner' decals
 - ★ Bonnet scoops
 - ... and with these Falcon 500 Van features deleted: Bodyside protection mouldings and van side glass.



FORD ESCORT RECREATIONAL VAN

Wheels for the great escape

This addition to the Escort van range is a sporty, bold "escape machine" for young Australians who love the great outdoors. A roomy little van in either 1.6 litre or 2 litre models. It features comprehensive instrumentation, AM push-button radio, "houndstooth pattern" cloth seat inserts and door trims, and many sports-type features to suit the outdoor life. And here's the big news... the front seats tilt forward to give you room to stretch out when you're sleeping out. The side panels have sporty "bubble" windows, adding a special difference to the van's appearance.

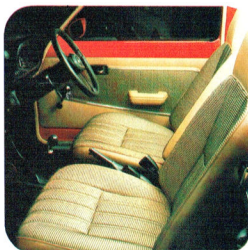

Illustrated above: Ford Escort Recreational Van interior.

FORD ESCORT RECREATIONAL VAN STANDARD EQUIPMENT HIGHLIGHTS

Including these features which are standard on Escort GL Van:

- ★ 1.6 litre crossflow head engine
- ★ 4-speed floorshift manual transmission
- ★ Power assisted front disc brakes
- ★ Centre console
- ★ Am push-button radio
- ★ Cigarette lighter (illuminated)
- ★ Outboard inertia reel seat belts
- ★ Loop pile carpeting in passenger compartment
- ★ Prismatic day/night interior rear view mirror

- ★ Styled right and left hand exterior rear view mirrors
- ★ Ventilation system with individual directional ball vents and under-dash vents
- ★ 2 speed heater/demister with illuminated slide controls
- ★ 2 speed windscreen wipers with 2 jet washers
- ★ Steering column control stalks for
 - Turn signal/lane change, high/low beam, headlight flasher, horn and
 - "Flick-wipe" windscreen wiper/washer.
- ★ Driver's side trinket tray
- ★ Front passenger side parcel shelf

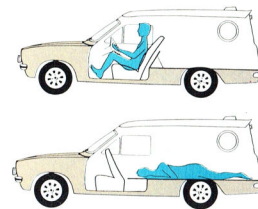

- ★ Hazard flashers
- ★ Headlining in load area
- ★ Quartz halogen headlights and with these additional features which are not standard on Escort GL Van.
- ★ ZR70S steel-belt radial tyres
- ★ Styled steel sports-type wheels with chrome finish trim rings
- ★ Long range driving lights
- ★ Comprehensive instrumentation including tachometer, fuel and temperature gauges, odometer, speedometer and trip-meter
- ★ Load area fluorescent roof light
- ★ Load area front extension located behind bucket seats
- ★ Front bucket seats with forward folding mechanism
- ★ "Houndstooth pattern" cloth inserts on front bucket seats and door trims
- ★ 254 mm (10") diameter tinted bubble windows in rear compartment
- ★ Black vinyl cover for spare wheel located in rear load compartment
- ★ Distinctive exterior striping and decal
- ★ Black finish bumperettes with front bumper overriders
- ★ Soft-rim sports steering wheel
- ★ Black-out paint treatment
- ★ Interior rear door release handle
- ★ Loop pile carpet in load area



Illustrated above: Ford Falcon 500 Utility with optional 4.1 litre engine (available at extra cost).

FORD FALCON AND FALCON 500 UTILITIES & VANS

Big... strong... comfortable... with performance to match

Falcon and Falcon 500 Utes and Vans are tried and tested workmates with strength, power and reliability ready to take on tough Australian road conditions... and for "getting away from it all".

A 3.3 litre crossflow engine delivers the necessary power with the economy of standard grade fuel. Power-assisted front disc brakes help you stop smooth and sure. There's the strength that comes from torque-box chassis construction, all steel floor, and load-matched suspension for jobs up to 750 kg (15 cwt).

For your comfort, there are deeply cushioned reclining bucket seats in Falcon 500 and full-width bench seats in Falcon - both with folding centre armrests. Fan-boosted ventilation. 3-speed heater-demister. And... good news for Van purchasers, you've now a choice of rear lift-gate or side-hinged doors. Lift-gate standard on Falcon 500 Van. Side-hinged doors standard on Falcon Van.

FORD FALCON UTILITY AND VAN STANDARD EQUIPMENT HIGHLIGHTS

- ★ 3.3 litre crossflow head 6-cylinder engine
- ★ 3-speed column shift manual transmission
- ★ Power front disc brakes
- ★ Prismatic day/night interior rear view mirror
- ★ Styled left and right hand side exterior rear view mirror
- ★ High-backed bench seat with folding centre armrest
- ★ Padded door-pull armrests incorporating door handles
- ★ Lockable glove box



Illustrated above: Falcon 500 Utility interior with optional T-Bar automatic transmission and push-button radio (available at extra cost).

- ★ Steering and ignition lock
- ★ 3-speed heater demister
- ★ Steering column control stalk for turn indicators, lane change, hi-lo beam, headlight flasher and horn button
- ★ Roof insulation
- ★ Side hinged rear doors (van)

FORD FALCON 500 UTILITY AND VAN STANDARD EQUIPMENT HIGHLIGHTS

As for Falcon models but with these upgraded features:

- ★ Reclining bucket seats with folding centre armrest
 - ★ Quartz halogen headlights
 - ★ Loop pile carpet in passenger compartment
 - ★ Lift tail-gate (van)
- and with these additional features which are not standard on Falcon:
- ★ Interior courtesy light operated by both doors
 - ★ Cigar lighter
 - ★ Bodyside protection mouldings
 - ★ Floor mat in load area (van)
 - ★ Side glass in load compartment (van)
 - ★ Complete headlining in load area (van)
 - ★ Tonneau cover (utility)



Illustrated above: Ford Falcon 500 Van with optional GS Rally Pack and 4.9 litre engine (available at extra cost).



FORD F100 4 WHEEL DRIVE

From highway to hillside, driveway to dockside — Ford F100 4-Wheel Drive takes Australia in its stride. For the farmer, fisherman, hunter and miner — it's the "big country" machine.

F100 4-Wheel Drive. Try it for size. Brute strength from a V8 engine. 4-Wheel Drive toughness.

It's the rakish, rugged and reliable machine with comfort up front and good load space behind. Discover F100 4-Wheel Drive — the way to explore the big country.

THE XLT OPTION PACK (AVAILABLE AT EXTRA COST) INCLUDES:

- AM Mono push-button radio
- Loop-pile carpet
- Houndstooth pattern cloth seat inserts
- White vinyl tonneau cover
- White roof
- Front bumper overriders
- Steel spoked wheels
- Rear step bumper
- Lowline "Swinglok" exterior rear-view mirrors
- XLT badges
- Bodyside protection mouldings
- Bright windscreen and rear window surrounds
- Bright drip rails, wheels arch, rocker panel and tailgate mouldings.

F100 4-WHEEL DRIVE SPECIFICATIONS

Engine: 4.9 litre (302 CID) V8 with 4 Venturi carburettor.

Transmission: 4-speed floorshift with synchromesh on 2nd, 3rd and 4th. SAE Pattern 6 bolt opening on right hand side.

Transmission Ratios (to 1): 6.69; 3.34; 1.66; 1.00; Reverse 8.25.

Clutch: Twin dry plate 241 mm (9.5 in) diameter, diaphragm pressure plate, hydraulic actuation.

Brakes: Dual line, power-assisted hydraulic, 293 mm (11.54 in) front disc brakes and 280 mm x 57 mm (11 in x 2.25 in) rear self-adjusting drum brakes.

Front Suspension: Coil springs with shock absorbers.

Rear Suspension: Leaf springs with shock absorbers and stabilizer bar.

Front Axle: Dana 44 — 7F full floating ratio — 4.09:1 Manual locking-hubs.

Rear Axle: Ford semi-floating ratio — 4.1:1.

Wheels: 15 x 6JK, 5 stud standard. 15 x 8 steel spoke 5 stud wheels standard with XLT option pack.

Tyres: 7.00 x 15 x 8 PR, all purpose lugread pattern standard. 10 x 15 LT all purpose lugread standard with steel spoke wheels on XLT pack.

Fuel Tank Capacity: 72 litres (16 gallons).

Wheelbase: 2972 mm (117 in) or 3380 mm (133 in).



Illustrated: Ford F100 4-Wheel drive with XLT option pack (available at extra cost).

Ford Falcon Sundowner, Falcon and Falcon 500 Utilities and Vans Options and Specifications (Options are at extra cost.)

CONVENIENCE EQUIPMENT

	Falcon Van	Falcon 500 Van	Falcon Utility	Falcon 500 Utility	Falcon Sun-downer
Integrated air conditioning	(a) OPT	OPT	OPT	OPT	OPT
Variable ratio power steering	(b)	OPT	OPT	OPT	OPT
AM push-button radio with lock-down aerial	OPT	OPT	OPT	OPT	OPT
AM/FM Multiplex radio with lock-down aerial	OPT	OPT	OPT	OPT	OPT
Stereo cassette tape player	OPT	OPT	OPT	OPT	OPT
'Houndstooth' cloth seat upholstery	NA	OPT	NA	OPT	OPT
Carpeting—loop pile	OPT	STD	OPT	STD	NA
—Cut pile	NA	NA	NA	NA	STD
Bucket seat with pull-down centre armrest	NA	STD	NA	STD	NA
Bucket seat with sports console/armrest	(c)	NA	OPT	NA	OPT
Bench seat with folding centre armrest	STD	NCO	STD	NCO	NA
Rubber floor mat	STD	O/R	STD	O/R	NA
Side hinged rear doors	STD	OPT	NA	NA	NA
Lift Tailgate doors	OPT	STD	NA	NA	STD
Body-side protection mouldings	OPT	STD	OPT	STD	NA

HEAVY DUTY EQUIPMENT

Outback Package	(d)	OPT	OPT	OPT	OPT
Class I Towing Pack (refer page 37)	OPT	OPT	OPT	OPT	OPT
Class II Towing Pack (refer page 37)	(e)(m)	OPT	OPT	OPT	OPT
500 kg (10 cwt) 'sedan ride'	OPT	OPT	OPT	OPT	STD
750 kg (15 cwt) suspension	STD	STD	STD	STD	OPT

SPORTS EQUIPMENT

GS Rally Pack	(f)	OPT	OPT	OPT	OPT	NA
Limited-slip differential	(g)	OPT	OPT	OPT	OPT	OPT
152.4 mm (6") alloy sports road wheels	OPT	OPT	OPT	OPT	OPT	OPT
Four-wheel power disc brakes	(h)	OPT	OPT	OPT	OPT	OPT
Styled wheel covers	OPT	OPT	OPT	OPT	NA	NA
Front bumper over-riders	OPT	OPT	OPT	OPT	NA	NA
Styled right hand remote control exterior rear-view mirror	OPT	OPT	OPT	OPT	OPT	OPT
Long range driving lights	(i)	OPT	OPT	OPT	OPT	STD
Tinted band, laminated windshield	OPT	OPT	OPT	OPT	OPT	OPT
Van side glass	OPT	STD	NA	NA	OPT	OPT
Delete van side glass	NA	OPT	NA	NA	STD	STD
Tonneau cover	NA	NA	OPT	STD	NA	NA

ENGINE AND TRANSMISSION COMBINATIONS

	Falcon Van	Falcon 500 Van	Falcon Utility	Falcon 500 Utility	Falcon Sun-downer
3.3 litre (crossflow) 'Six' with:					
All-synchro 3-speed manual column shift	(b)	STD	STD	STD	STD
3-speed automatic column shift	OPT	OPT	OPT	OPT	NA
4.1 litre (crossflow) 'Six' with:					
All-synchro 3-speed manual column shift	(b)	OPT	OPT	OPT	OPT
All-synchro 4-speed manual floor shift	(c)	NA	OPT	NA	OPT
3-speed automatic column shift	OPT	OPT	OPT	OPT	NA
3-speed T-bar automatic floor shift	(c)	NA	OPT	NA	OPT
4.9 litre (4-barrel) V8 with:					
All-synchro 4-speed manual floor shift	(a)(c)	NA	OPT	NA	OPT
3-speed automatic column shift	OPT	OPT	OPT	OPT	NA
3-speed T-bar automatic floor shift	(c)	NA	OPT	NA	OPT
GT POWER PACK OPTION					
5.8 litre (4-barrel) V8 with:	(a)	(i)			
All-synchro 4-speed manual floor shift	(c)	NA	OPT	NA	OPT
3-speed automatic column shift	NA	OPT	NA	OPT	NA
3-speed T-bar automatic floor shift	(c)	NA	OPT	NA	OPT

WHEELS AND TYRES

	Falcon Van	Falcon 500 Van	Falcon Utility	Falcon 500 Utility	Falcon Sun-downer
7.75 L14 Crossply tyres	STD	STD	STD	STD	NA
185 SR14 Textile radials	(k)	OPT	OPT	OPT	OPT
FR78 S14 4 ply steel-belt radials	(l)	OPT	OPT	OPT	OPT
FR70 H14 6 ply steel-belt radials	(m)	OPT	OPT	OPT	OPT

OPT means optional at extra cost. NA means not available on that model. NCO means no cost option. O/R means option at reduced cost.

Footnotes to charts on left:

- Power steering is mandatory at extra cost when air conditioning is fitted with V8 engines.
- Power steering is not available with 3-speed manual column shift transmission.
- Sports console must be fitted with floor-mounted transmissions and is not available with full-width seat.
- Outback package comprises increased diameter stabiliser bar, engine stone guard and heavy-duty air cleaner.
- 750 kg (15 cwt) suspension is mandatory with Class II towing packs.
- GS Rally Pack consists of special black paint treatment; styled steel road wheels; sports steering wheel; comprehensive instrumentation; bonnet scoops; front bumper overriders; long range driving lights.
- Limited slip differential is not available with 3.3 litre 6-cylinder engine. It is mandatory at extra cost when 5.8 litre V8 engine is specified.
- Four-wheel power disc brakes are optional at extra cost with 4.9 litre V8 engine and mandatory at extra cost with 5.8 litre V8 engine.
- Long range driving lights are standard when GS Rally Pack is specified on Falcon 500.
- Mandatory equipment, at extra cost, with the 5.8 litre engine: 4 wheel power disc brakes; limited slip differential; FR70 H14 steel belt radial ply tyres.
- Only available with 6-cylinder 500 kg (10 cwt) option.
- FR78S radials are mandatory with 4.9 litre engine.
- FR70 H14 Radial ply tyres must be specified with Class II Towing Pack and the 5.8 litre engine.

Engine Specifications: Refer to page 38 for specifications.

Always discuss your intended purchase carefully with your Ford dealer before placing your order.

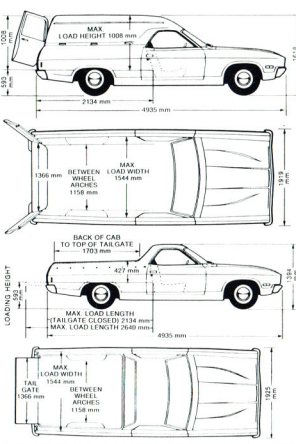

DIMENSIONS

	Utilities and Vans
Wheelbase	2946 mm (116")
Track—front	1536 mm (60.5")
—rear	1524 mm (60.0")
Ground clearance	162 mm (6.4")
Max. load length (tailgate down)	2640 mm (103.9")
Max. load length (tailgate closed)	2134 mm (84")
Max. loading height (unladen)	593 mm (23.3")
Fuel Tank capacity	67 litres (14.8 gall)
Turning circle	12.5 m (41.2 ft)
Cubic capacity (Vans)	2.7 m ³ (96 ft ³)

Please note: All measurements, dimensions and capacities referred to here are approximate only.

Ford Fairlane.
More ... much more ...
than style alone.



Illustrated above: Ford Fairlane Marquis. White sidewall tyres are no longer available on this model as an option.

FORD FAIRLANE 500

Engineered for pleasure and outstanding performance

Fairlane 500 is distinctively styled to set it apart from other cars, yet style is only the beginning of all the pleasures of owning Fairlane. A 4.9 litre V8 engine gives you quiet responsive power. The long wheelbase and wide track combine superbly for handling ease and riding smoothness. The long list of comfort appointments ensure quiet personal motoring for you and your passengers.



Illustrated above: Ford Fairlane 500. White sidewall tyres are no longer available on this model as an option.



Illustrated above: Ford Fairlane 500 with optional T-bar automatic transmission (available at extra cost).

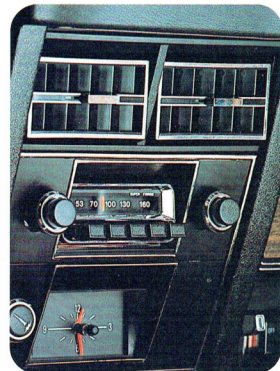
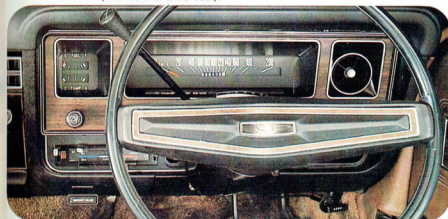

FORD FAIRLANE 500 STANDARD EQUIPMENT HIGHLIGHTS

- ★ 4.9 litre V8 engine with 4 barrel carburettor
- ★ 3 speed column change automatic transmission
- ★ 4 wheel power disc brakes
- ★ Steel belt radial ply tyres
- ★ Tinted-band laminated windscreen
- ★ Reclining front bucket seats
- ★ Outboard inertia reel front and rear seat belts
- ★ Prismatic interior day/night rear view mirror
- ★ Power assisted ventilation
- ★ Intermittent action windscreen wipers with anti-lift vane fitted to driver's side blade
- ★ 4 jet windscreen washers
- ★ 3 speed heater demister with illuminated controls
- ★ Steering column control stalk for turn signal/lane change, high/low beam, headlight flasher and dual tone horn
- ★ Cut pile carpet
- ★ Carpeted luggage compartment floor
- ★ "Mystique" grain vinyl seat upholstery
- ★ Styled remote control right hand exterior rear view mirror
- ★ Interior courtesy lights operated by all four doors
- ★ Lockable passenger side glove box
- ★ Passenger side parcel shelf
- ★ Driver's side trinket tray
- ★ Quartz halogen headlights
- ★ "Lights on" warning light
- ★ Electric rear window demister
- ★ Cigarette lighter built into front ashtray
- ★ Bodyside protection mouldings
- ★ Centre front armrest
- ★ AM push-button radio with power aerial
- ★ Electric quartz crystal clock
- ★ Limited slip differential
- ★ Front and rear bumper overrides
- ★ Front passenger side reading light
- ★ Foot operated parking brake
- ★ Courtesy lights for glove box and luggage compartment
- ★ Map reading lamp
- ★ Vinyl roof
- ★ Wheelcovers
- ★ Variable ratio power steering
- ★ Folding centre armrest in rear compartment

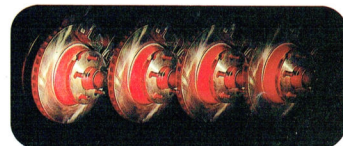



FORD FAIRLANE MARQUIS STANDARD EQUIPMENT HIGHLIGHTS

- As for Fairlane 500 but with these upgraded features:
- ★ Integrated air conditioning
 - ★ Split bench front seats with 6 way power adjustments
 - ★ "Cashmere" cloth seat upholstery
 - ★ Chrome finish remote control right hand and left hand exterior rear view mirrors
 - ★ Individual folding centre armrests on front seats
 - ★ Twin spot dome lamps
 - ★ Tinted side and rear windows
 - ★ Power operated windows
 - ★ "Soft-feel" steering wheel

FORD FAIRLANE MARQUIS

A beautiful way to reward yourself

Opportunities to reflect personal achievement come in many forms, not the least of which is the choice of a fine car.

Fairlane Marquis is such a car, undoubtedly a step above the well established Fairlane tradition for distinctive style and a high level of personal appointments.

Needless to say, in its power, overall performance and smooth ride and handling Marquis continues the Fairlane tradition.



Illustrated right: Ford Fairlane Marquis. White sidewall tyres and the sun roof are no longer available on this model as an option.

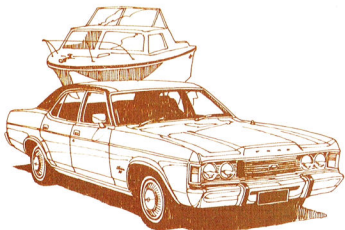

Ford Fairlane 500 and Fairlane Marquis Options and Specifications

(Options are at extra cost)

CONVENIENCE EQUIPMENT	Fairlane 500	Fairlane Marquis
Integrated air conditioning	(a) OPT	STD
Tinted side and rear glass	(a) OPT	STD
AM/FM Multiplex push-button radio	OPT	OPT
Stereo cassette tape player	OPT	OPT
Sun roof	OPT	NA
Styled left hand exterior rear-view mirror	OPT	NA
Cloth seat upholstery - "Cord"	OPT	NA
"Cashmere"	NA	STD
Vinyl seat upholstery	OPT	OPT
Long range fuel tank	OPT	OPT
POWER EQUIPMENT		
Power windows	OPT	STD
HEAVY DUTY EQUIPMENT		
Outback package	(b) OPT	OPT
Heavy-duty suspension	(c) OPT	OPT
Class I Towing Pack (Refer to page 37 for details)	OPT	OPT
Class II Towing Pack (Refer to page 37 for details)	(d) OPT	OPT
APPEARANCE EQUIPMENT		
*"Regency" paint (Blue and Bronze)	NA	OPT

- (a) Tinted side and rear glass is standard when air conditioning is specified.
 (b) Outback package consists of heavy duty shock absorbers and springs, increased diameter stabiliser bar, engine stone guard and heavy duty air cleaners.
 (c) Heavy duty suspension is included in both the Outback package and the Class II Towing Pack option.
 (d) FR78S 14 black sidewall tyres 6 ply rating are mandatory at extra cost when the 5.8 litre V8 engine is specified and when Class II towing pack is specified.

ENGINE AND TRANSMISSION COMBINATIONS	Fairlane 500	Fairlane Marquis
4.9 litre 4-barrel V8 with: 3-speed automatic column shift	STD	STD
3-speed T-bar automatic floor shift	OPT	NA
5.8 litre 4-barrel V8 with: 3-speed automatic column shift	(d)	OPT
3-speed T-bar automatic floor shift	OPT	NA

TYRES AND WHEELS AVAILABILITY	Fairlane 500	Fairlane Marquis
All wheels are 6JJ safety-rim		
ER78S 14 black sidewall steel-belt radials	STD	NA
FR78S 14 black sidewall steel-belt radials-4 ply	OPT	STD
FR78S 14 black sidewall steel-belt radials-6 ply	(d)	OPT

STD means standard equipment.

OPT means optional at extra cost.

NA means not available for this model.

Please note: All measurements, dimensions and capacities referred to above are approximate only.

DIMENSIONS		
Overall length	5179 mm (203.9")	
Overall width	1960 mm (77.16")	
Overall height	1387 mm (54.6")	
Wheelbase	2946 mm (116.0")	
Track - front	1539 mm (60.6")	
- rear	1527 mm (60.1")	
Fuel tank capacity	79.6 litres (17.5 gallons)	
Optional long range fuel tank capacity	120.5 litres (26.5 gallons)	
Turning circle	12.9 m (42.4')	
ENGINE SPECIFICATIONS		
	4.9 litre 4 barrel V8	5.8 litre 4 barrel V8
Engine displacement (cc)	4900	5800
Bore (mm)	101.6	101.6
Stroke (mm)	76.2	88.9
Compression ratio (to 1)	9.2	8.9

Driver and passenger protection:

The following items are built-in to both Fairlane models to lessen the likelihood of an accident occurring and to help prevent personal injury in the event of an accident:

- ★ 4-wheel power disc brakes
- ★ Dual hydraulic brake system and warning light
- ★ Front and rear outboard inertia reel seat belts
- ★ Highbacked front seats
- ★ Recessed, padded instrument panel
- ★ Steering column designed to collapse at a predetermined load under impact conditions
- ★ Impact absorbing steering wheel
- ★ Controlled collapsible front end
- ★ Padded sun visors
- ★ Padded door pull armrests
- ★ Door mounted grab visors
- ★ Tinted-band, laminated windscreen and safety glass in all other windows
- ★ Windscreen mounted, breakaway, anti-glare interior rear view mirror
- ★ Exterior rear view mirrors
- ★ Electric rear window demister
- ★ Quartz halogen headlights
- ★ Reversing lights
- ★ Front and rear side marker lamps
- ★ Wrap around front turn indicators
- ★ 2 speed electric windscreen wipers with intermittent wipe action and push-button washer control
- ★ Non-reflective wiper blades with anti-lift vane fitted to driver's side blade
- ★ Dual tone horn
- ★ Steering column stalk control for hi-lo beam, headlight flasher, turn and lane change indicators.
- ★ Side impact/intrusion bars.

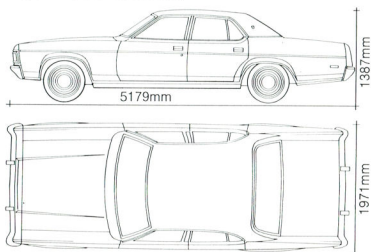

Ford LTD... Australia's luxury limousine.



Ford LTD. White sidewall tyres are no longer available on this model as an option.

Printed December 1977



Presenting Australia's luxury limousine . . .

Ford LTD is designed and engineered as one of Australia's most distinguished sedans. Of all prestige motor cars, it is one of the largest and most spacious on the Australian road. The contoured leather faced front seats are individually adjustable and reclining, allowing you and your front seat passenger to select your own seating positions for relaxed travelling—particularly over long distances.

You're provided with a high degree of motoring satisfaction from its all-round performance—the responsiveness of a 5.8 litre V8 engine with T-bar automatic transmission, smoothness of ride from a long wheelbase, ease of handling from variable-ratio power steering and fast, predictable stopping from power-assisted ventilated disc brakes at all four wheels combined with steel belt radial tyres.

Ford LTD provides an extensive list of standard appointments included in the price you pay. For example, an integrated air conditioning system with rear compartment outlets and a stereo cassette player.

You are invited to experience Ford LTD for yourself. The way it feels to take the wheel, turn the key and leave the ordinary world behind.





FORD LTD Silver Monarch Edition

The LTD limousine includes an extensive range of luxury features as standard equipment.

Nevertheless, the Silver Monarch Edition, available at extra cost, offers a group of features that add considerable distinction to this already fine limousine.

For example, this model comprises a special paint treatment including a time-consuming cut-and-polish operation to provide a superb finish, which combines with a colour-keyed vinyl roof to give a subtle look of refinement.

The seats are upholstered in "Cranberry Red" crushed velour cloth and the carpet and door trim is colour-keyed.

FR78S steel-belt radials with 6 ply rating are fitted to enhance road stability at highway cruising speeds.

The special paint treatment and interior trim are currently reserved for exclusive use in the Silver Monarch Edition and are not available separately. Before you order your LTD, ask your authorised Ford Dealer to show you cloth and paint samples for the "Silver Monarch".



Please note: White sidewall tyres are no longer available on Ford LTD "Silver Monarch".

Ford LTD Options and Specifications (Options are at extra cost)

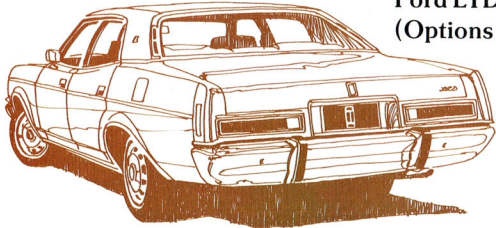

Driver and passenger protection:

The following items are built-in to Ford LTD to lessen the likelihood of an accident occurring and to help prevent personal injury in the event of an accident:

- ★ 4-wheel power disc brakes ★ Dual hydraulic brake system and warning-light ★ Front and rear outboard inertia reel seat belts ★ Highbacked front seats
- ★ Recessed, padded instrument panel ★ Steering column designed to collapse at a predetermined load under impact conditions ★ Impact absorbing steering wheel ★ Controlled collapsible front end
- ★ Padded sun visors ★ Padded door pull armrests
- ★ Door mounted grab handles ★ Laminated windscreen and safety glass in all other windows
- ★ Windscreen mounted, breakaway, anti-glare interior rear view mirror ★ Exterior rear view mirrors
- ★ Electric rear window demister ★ Quartz halogen headlights ★ Reversing lights ★ Front and rear side marker lamps ★ 2 speed electric windscreen wipers with intermittent wiper action and push-button washer control
- ★ Non-reflective wiper blades with anti-lift vane fitted to driver's side blade ★ Dual tone horn
- ★ Steering column stalk control for hi-lo beam, headlight flasher, turn and lane change indicators.
- ★ Side impact/intrusion bars.

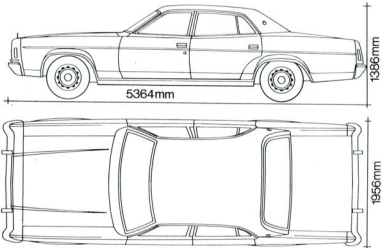

Please note: All measurements, dimensions and capacities referred to above are approximate only.

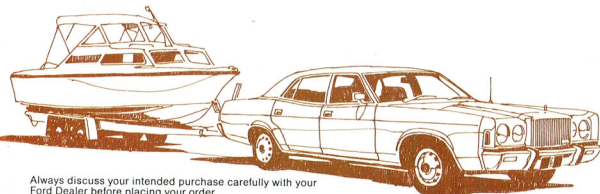

Always discuss your intended purchase carefully with your Ford Dealer before placing your order.

CONVENIENCE EQUIPMENT	
AM/FM Multiplex push-button radio	Ford LTD
Cloth seat upholstery—"Velour"	OPT
HEAVY DUTY EQUIPMENT	
Touring suspension	OPT
Class I Towing Pack (Refer page 37 for details.)	OPT
Class II Towing Pack (Refer page 37 for details.)	OPT
SPORTS EQUIPMENT	
Long range fuel tank—118 litres (26 gallons)	OPT
ENGINES AND TRANSMISSIONS	
The 5.8 litre with 4 barrel carburettor coupled to the 3-speed automatic floor shift is standard equipment in the Ford LTD.	
TYRES AND WHEELS	
FR785 14 steel belt black sidewall 6 ply rating—6JJ wheels	STD

Dimensions:	
Overall length	5366 mm (211.3")
Overall width	1960 mm (77.2")
Overall height	1393 mm (54.9")
Wheelbase	3073 mm (121.0")
Track—front	1539 mm (60.6")
—rear	1527 mm (60.1")
Fuel tank capacity	79.6 litres (17.5 gallons)
Optional long range fuel tank capacity	120.5 litres (26.5 gallons)
Turning circle	13.04 m (42.8')
Engine Specifications:	
Engine displacement (cc)	5800
Bore (mm)	101.6
Stroke (mm)	88.9
Compression ratio (to 1)	8.9

Servicing and Maintenance

After the initial 1500 km servicing, your new Ford will only require routine servicing every 10,000 km under normal driving and operating conditions. Ask your authorised Ford Dealer to advise you on service requirements for abnormal driving and operating conditions.



FORD ESCORT
2 DOOR L SEDAN



FORD ESCORT
2 DOOR GL SEDAN



FORD ESCORT
4 DOOR GL SEDAN



FORD
ESCORT
GHIA



FORD ESCORT
L VAN

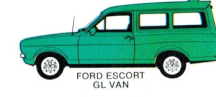

FORD ESCORT
GL VAN

FORD ESCORT



FORD
CORTINA
L SEDAN



FORD
CORTINA
GL SEDAN



FORD
CORTINA
GHIA SEDAN

FORD CORTINA

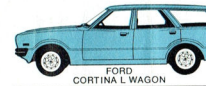

FORD
CORTINA
L WAGON



FORD
CORTINA
GL WAGON



FORD
FALCON
SEDAN

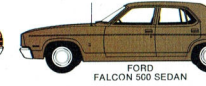

FORD
FALCON
500 SEDAN

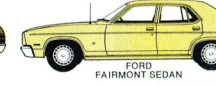

FORD
FAIRMONT
SEDAN

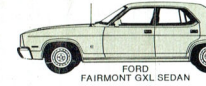

FORD
FAIRMONT
GXL SEDAN

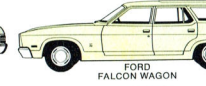

FORD
FALCON
WAGON

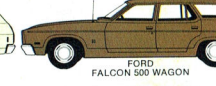

FORD
FALCON
500 WAGON

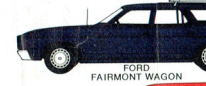

FORD
FAIRMONT
WAGON



FORD
FALCON
GS HARDTOP

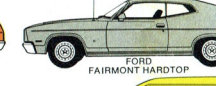

FORD
FAIRMONT
HARDTOP



FORD
FALCON
VAN



FORD
FALCON
500 VAN



FORD
FALCON
SUNDOWNER VAN

FORD FALCON



FORD
FALCON
UTILITY



FORD
FALCON
500 UTILITY

FORD FAIRLANE



FORD
FAIRLANE
500 SEDAN



FORD
FAIRLANE
MARQUIS SEDAN

FORD LTD



FORD LTD
SEDAN



FORD LTD SEDAN
"SILVER MONARCH"

OPTIONS MAKE ALL THE DIFFERENCE . . .

All Ford cars are designed and built to give you the best value possible. That's why there is such a wide choice of models available—to give you just the car you want. But, of course, there's always room for the individual touch. So, even though the Ford you choose offers a comprehensive number of features as standard equipment, there are still

some factory fitted options available at extra cost if you want them.

Some of these are illustrated below, but to find out just which options are available on which model, please consult your Ford Dealer and discuss your intended purchase carefully before placing your order.



Sliding Steel Sun Roof



'Houndstooth' Cloth Seat Trim

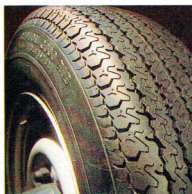

Steel belt Radial Tyres



Sports Alloy Road Wheels

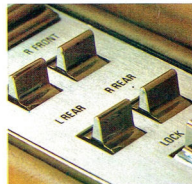

Power-operated Windows



GS Instrumentation



Tinted band Laminated Windscreen

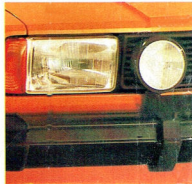

Long range Driving Lights



T-Bar Automatic

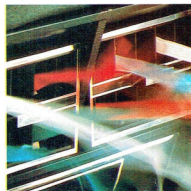

Integrated Air Conditioning



Remote-Control Driver's Side Rear-view Exterior Mirror



Bumper Overriders

The illustrations, information and specifications presented and referred to herein were correct at the time this publication was approved for printing. However, Ford Motor Company of Australia Limited and/or Ford Sales Company of Australia Limited reserve(s) the right, subject to the laws of Australia and/or any applicable State or Territory thereof and/or the regulations of any competent authority which may apply from time to time, at their or its discretion, and without notice, to discontinue or change the specification or design of the products referred to herein and any options therefor at any time without incurring any liability whatsoever to any purchaser thereof.

Some of the items illustrated or referred to herein are optional at extra cost. Some options may be required in combination with other options.

Always consult your Ford Dealer for the latest information on models, specifications, features, prices, options and availability.

FORD MOTOR COMPANY OF AUSTRALIA LIMITED
FORD SALES COMPANY OF AUSTRALIA LIMITED
1735 Sydney Road, Campbellfield, Victoria

